

not present Ch C

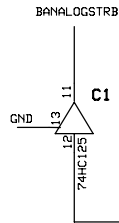

TO PAGE 1

TO PAGE 2

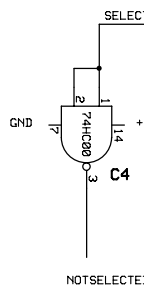

NOTSELECTED

- DB0
- DB1
- DB2
- DB3
- DB4
- DB5
- DB6
- DB7

- SELRCR
- SELRCPR
- SELRCAR
- SELRCAB
- SELRCAC
- SELRCAD

- SPARE LOGIC
- SPARE LOGIC

- TRK 1 OUT
- TRK 2 OUT
- TRK 4 OUT
- TRK 8 OUT
- TRK A OUT
- TRK B OUT
- TRK C OUT

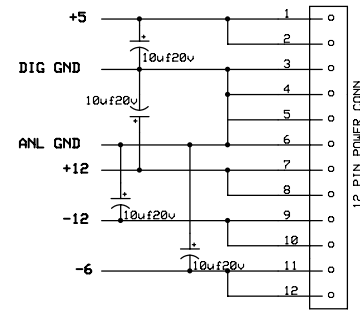
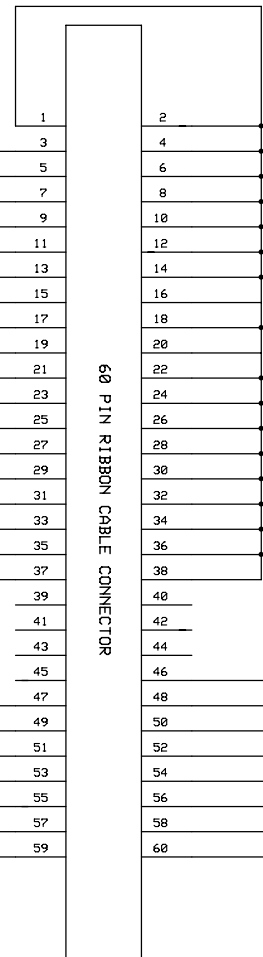

POWER CONNECTOR  
A2

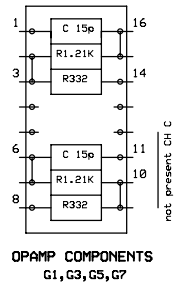
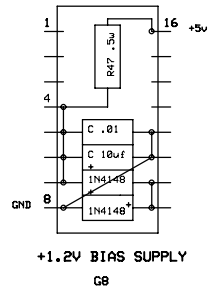
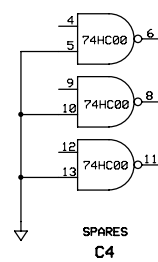

not present Ch C

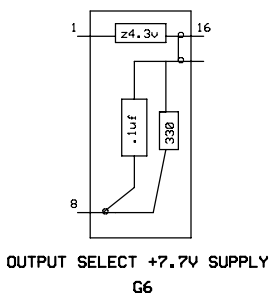
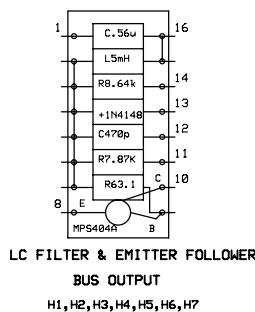

ONLY NUMBERED PINS ARE USED AS WIRE WRAP PINS  
ON COMPONENT CARRIERS

729 EMULATOR ANALOG SECTION		
CONNECTORS & MISC		
GRANT SAVIERS	Rev 10.0 4/30/2006	PAGE 3 OF 3