

ENDICOTT, NEW YORK  
CUSTOMER ENGINEERING

FORM NO. 229-2039

PRINTED IN U.S.A.  
MAY, 1963

IBM Custom  
Library

*Handwritten signature*

# SERVICE INDEX

# 1403

Printer

Machine Serial

# FOREWORD

## IBM 1403 SERVICE INDEX

The IBM Service Index was developed to provide the field with a reference to aid in troubleshooting. Diagnostic charts have been developed to aid the Customer Engineer in diagnosing machine problems. Service hints have been written along with the diagnostic charts so that as much information as possible was included. Logic flow charts are included as a quick refresher to proper operation of specific circuits. Information was analyzed from IR's for a three months period. Additional information was secured with the co-operation of Endicott Department of Education, Product Engineering Department, and Customer Engineering Department.

## HOW TO USE SERVICE INDEX

1. A. Determine symptom. (Observe machine in operation.  
Obtain as much information as possible from the operator.)
- B. Review correct and incorrect printed reports.
- C. Run diagnostics.
2. Locate symptom in Table of Contents.
3. Follow the Diagnostic Chart to determine probable cause.
4. Check the Service Hints to aid in troubleshooting.
5. Information in the Service Index can be used by the C.E.  
as a quick refresher to proper operation of specific circuits.

The following symbols are used throughout the index:

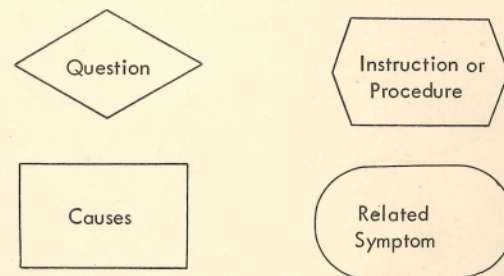

## GENERAL INFORMATION

Customer personnel most familiar with machine and programming. \_\_\_\_\_

Customer Engineer most familiar with machine. \_\_\_\_\_

Machine Serial # \_\_\_\_\_

Special features or unusual application. \_\_\_\_\_

# TABLE OF CONTENTS

TITLE	PAGE
SERVICE HINT REFERENCE .....	2
1403 CARRIAGE LOGIC DIAGRAM .....	3
CARRIAGE FAILURES	
WAVY PRINTING .....	4
SPACE FAILURES .....	6
SKIP FAILURES .....	8
CARRIAGE RUNNING AWAY .....	10
CARRIAGE SPACE CONTROL TIMING .....	11
SKIP TIMING .....	11
FORM CONTROL OP .....	12
CARRIAGE FAILURE SERVICE HINTS .....	14
TERMINAL BLOCK LOCATION CHART .....	23
SPACE KEY .....	26
RESTORE KEY .....	26
PRINT QUALITY SERVICE HINTS .....	27
RIBBON DRIVE TROUBLE .....	29
FORMS STACKING TROUBLE .....	31
1401 OR PRINTER STOPS .....	32
SYNC CHECKS .....	34
SYNC CHECK SERVICE HINTS .....	36
PRINTER TIMING CONTROL .....	36
PSS COUNTER .....	38
PRINT CHECKS .....	42
PRINT DATA FLOW .....	44
PRINT OP - BUFFER .....	45
PRINT OP TIMING - BUFFER .....	47
PRINT OP- NON-BUFFER .....	50
PRINT OP TIMING - NON-BUFFER .....	52
PRINT CHECK SERVICE HINTS .....	55
HAMMER RESET AND RESET TIMING .....	56
PRINT CHECK LOGIC .....	57
RESET CHECK LOGIC .....	58
PRINTABLE CHARACTER TABLE .....	60
UNITS & TENS DRIVER OUTPUT .....	61
STORAGE PRINT OUT .....	61

# SERVICE HINT REFERENCE

PG.	S.H.	TITLE
14...	1.	Forms Tractor
	2.	Hydraulic Belt
	3.	Emitter Brush
	4.	Hydraulic Carriage Waveform (on P.M.)
	5.	Valve Block Assembly (Magnet Assembly)
	6.	Erratic Carriage Failures
15...	7.	1403 Hydraulic Unit Reassembly
	8.	Carriage Failing to Move (Broken Valve Stem)
	9.	Belt-Yoke
	10.	Carriage Sync Points
	11.	Check Valves
16...	12.	Carriage Adjustment-Dash Method
18...	13.	Carriage Adjustment-Tach-Generator Method
22...	14.	Special Skip Cases
23...	15.	Valve Body
	16.	Special tool (Valve Body Removal)
	17.	Form Control Diagnostics
	18.	Procedure to Check Slow Brushes
24...	19.	Scoping Carriage Controls
25...	20.	Magnetic Emitter Adjustment
	21.	Broken Valve Stem
	22.	Valve stem lock nuts
27...	23.	Density Variation (Light Printing) A-P
	24.	Light tops or bottoms
28...	25.	Heavy Stroke Width
	26.	Light Stroke Width-All Characters
	27.	Light Stroke Width-Individual Hammers
	28.	Phantom Printing
	29.	Slur
	30.	Wavy Printing
	31.	Smudge Printing
	32.	Cartridge Mounting
	33.	Paper Guards Removal
	34.	Shimming Nose Cone (For Card Stock Forms)
	35.	Chain Cleanliness
	36.	Identification of Hammer Assemblies

PG.	S.H.	TITLE
30...	37.	Ribbon Stalling
	38.	Reverse Drag Friction Rings
	39.	Ribbon Skew Failures
	40.	Ribbon Reverse Failures
31...	41.	Stacker Tension Springs
33...	42.	Intermittent 1403 Stopping
	43.	Forms Tractor Adjustments
34...	44.	Sync and Print Checks
	45.	Chain Oiler Adjustment
36...	46.	Binding Chain
	47.	Method of Checking Drum Pulse
37...	48.	Method of Checking P.S.S. Pulse Variation
	49.	Chain Motor Bevel Gears
38...	50.	Check Buffer Clock
	51.	Checking Advance of P.S.S. Counter (Buffer)
41...	52.	Intermittent False Sync Checks
	53.	Sync Checks Caused By Noise
	54.	Thermal Lights
55...	55.	Intermittent Print Checks (Blown Fuses)
	56.	Checking Counters and Rings
57-61.		Troubleshooting Print Check Techniques
	62.	Fails to Print With No Print Checks
	63.	Print Magnet Coil Resistance
	64.	Troubleshooting Print Check Technique
	65.	Intermittent Print Checks (Missing Voltage)
	66.	Checking Hammer Flight Time
	67.	Print Magnet
	68.	Check Hammer Driver Fuse For Correct Size
	69.	Isolate Errors (Print Reset Checks)
	70.	Sync Points (Print Checks)
56...	71.	Blowing Hammer Driver Fuses
57...	72.	Print Checks
58...	73.	Reset Checks
59...	74.	Print Checks Caused By Noise
	75.	Display Print Buffer-1401
60...	76.	Scope Operating Procedures
	77.	Printable Character Table Explanation

# 1403 CARRIAGE LOGIC DIAGRAM

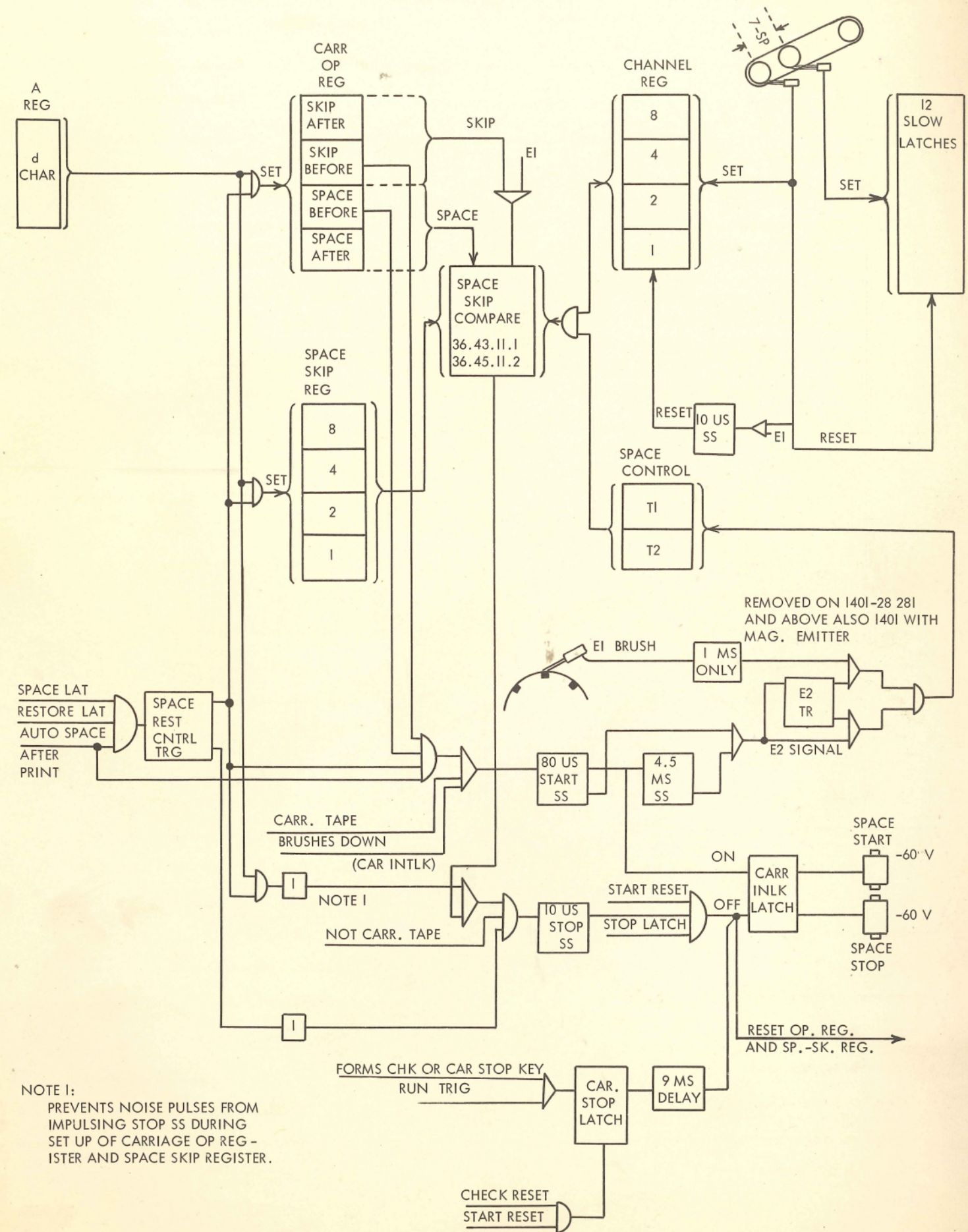

# CARRIAGE FAILURES WAVY PRINTING

WAVY PRINTING CAN ALSO BE REFERRED TO AS UNEVEN PRINTING

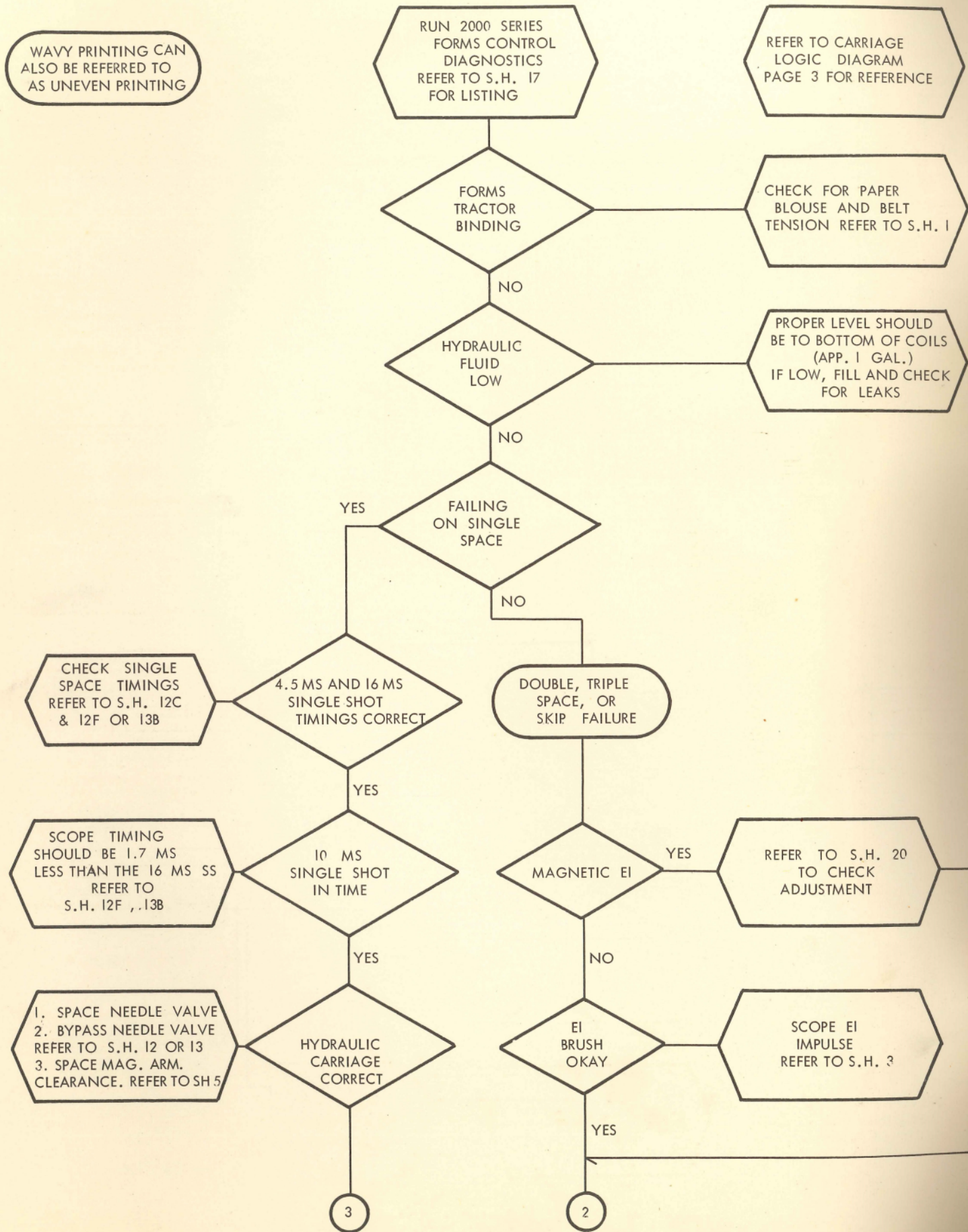

# WAVY PRINTING

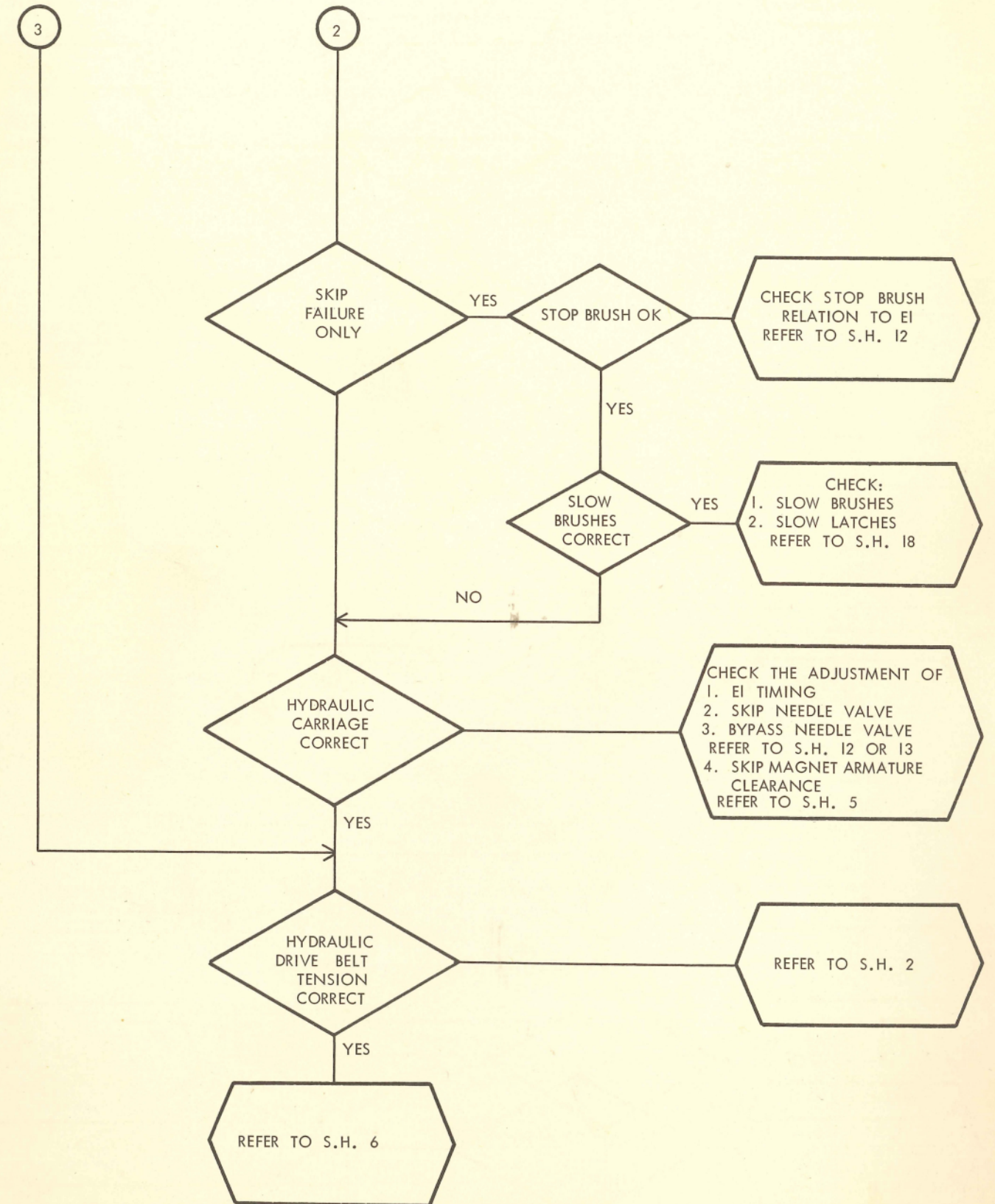



# SKIP FAILURES

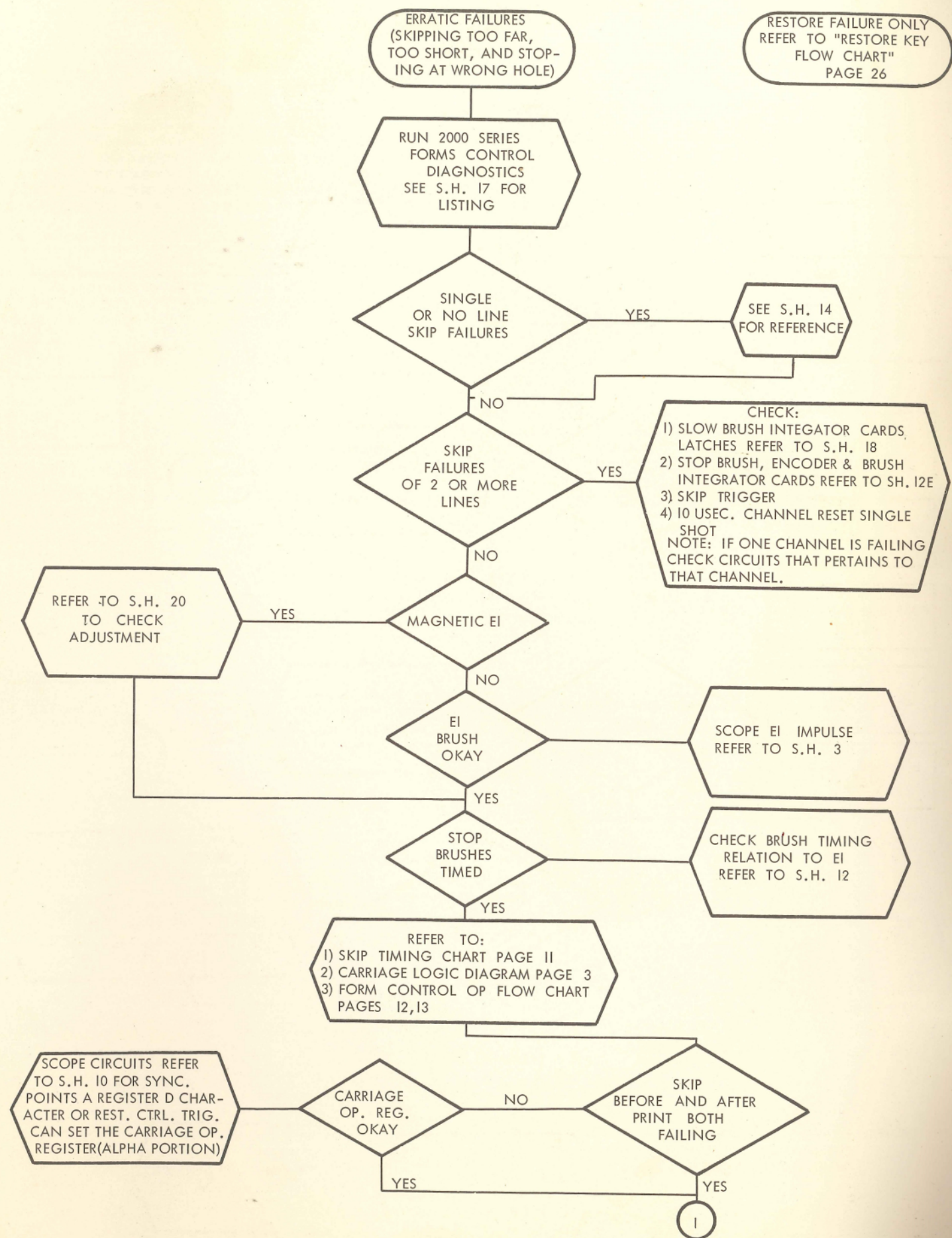

# SKIP FAILURES

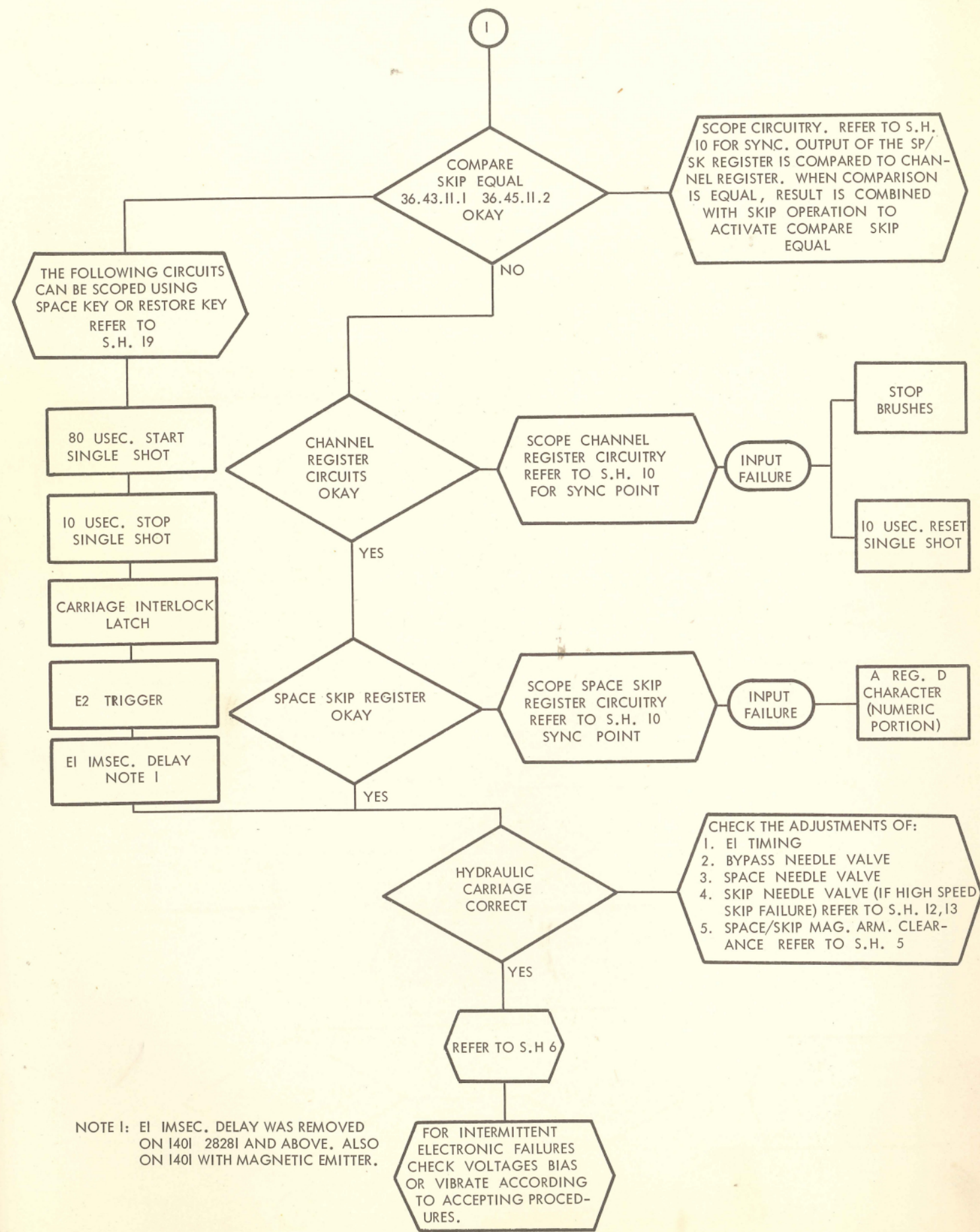

# CARRIAGE RUNNING AWAY

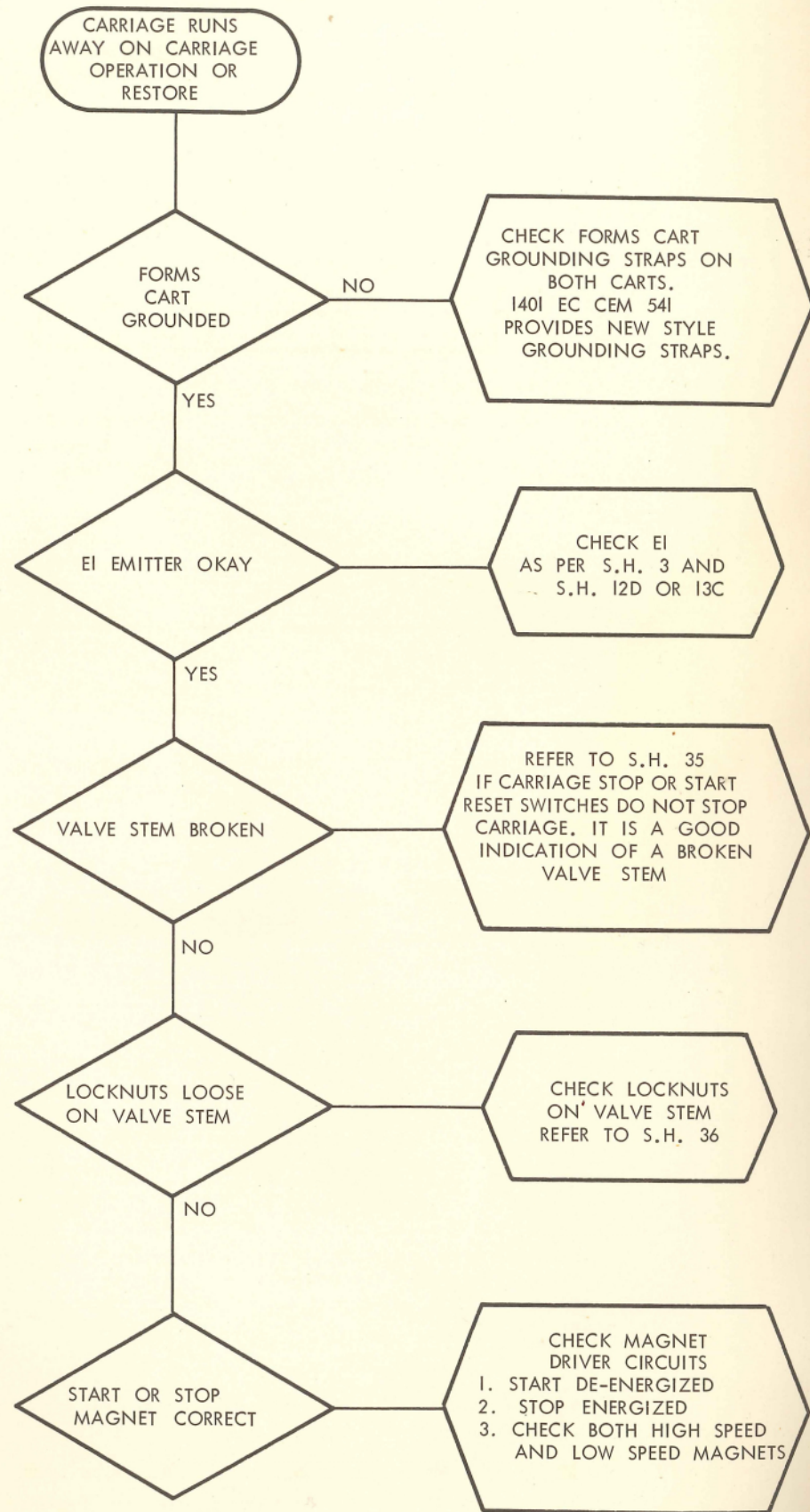

# CARRIAGE SPACE CONTROL TIMING

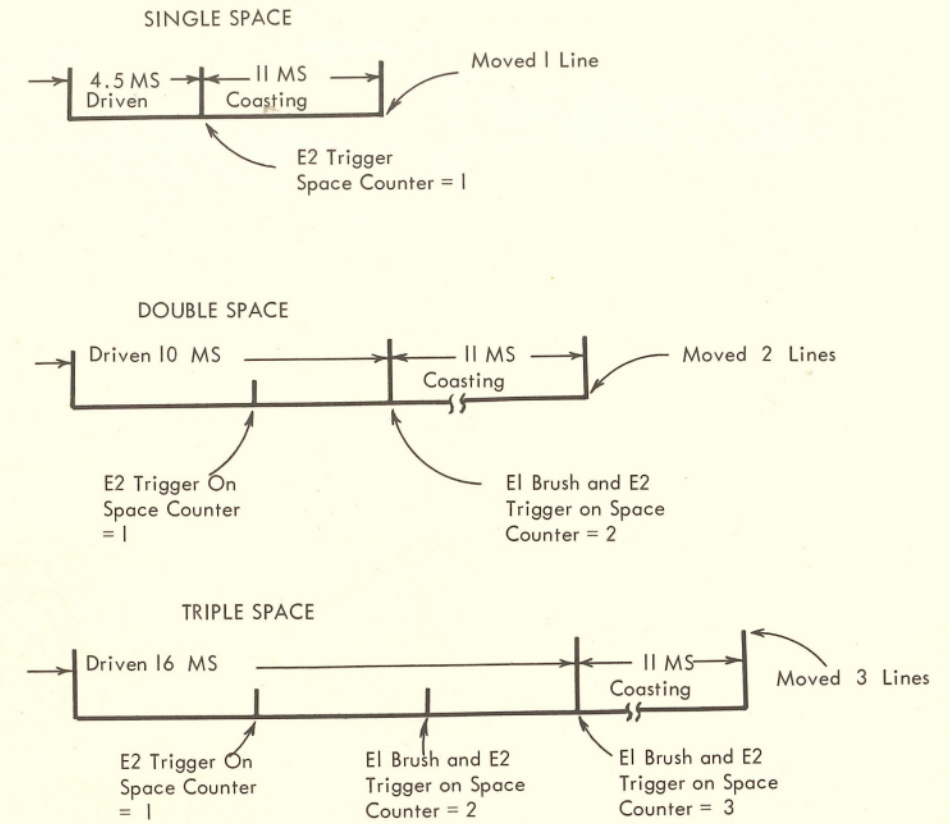

Note: All timings are approximate.

# SKIP TIMING

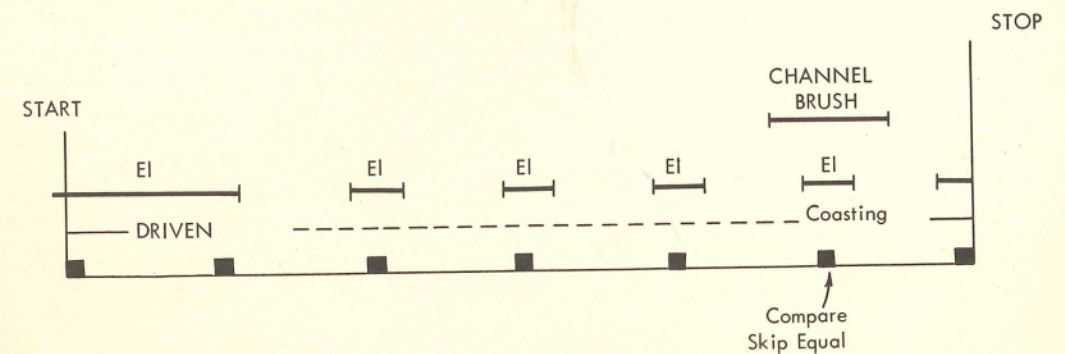
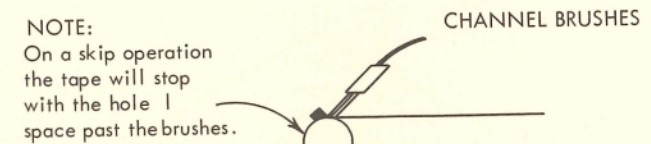

When skipping more than one line, signal to stop must come 1 space before same as double or triple space.

# FORM CONTROL OP

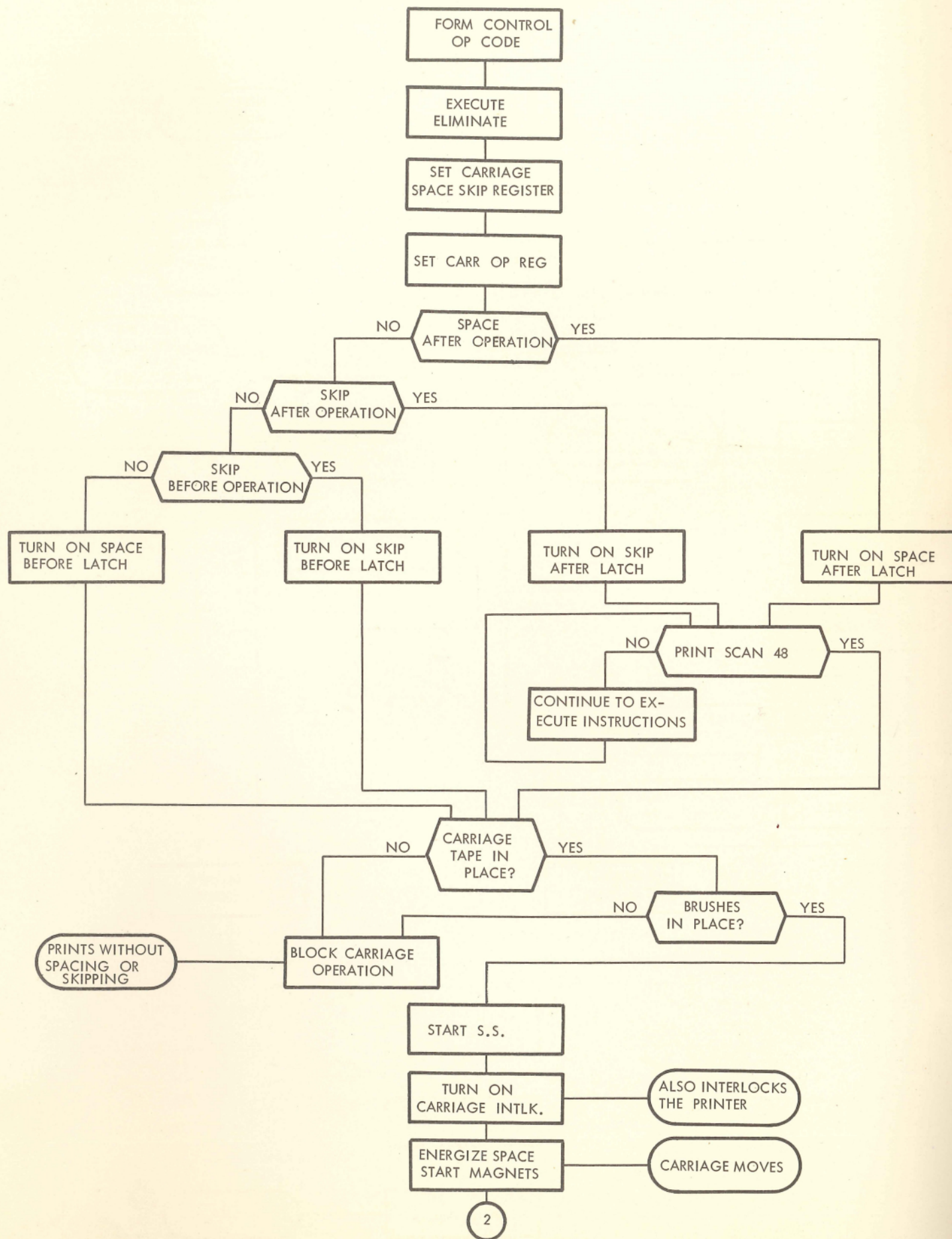

# FORM CONTROL OP

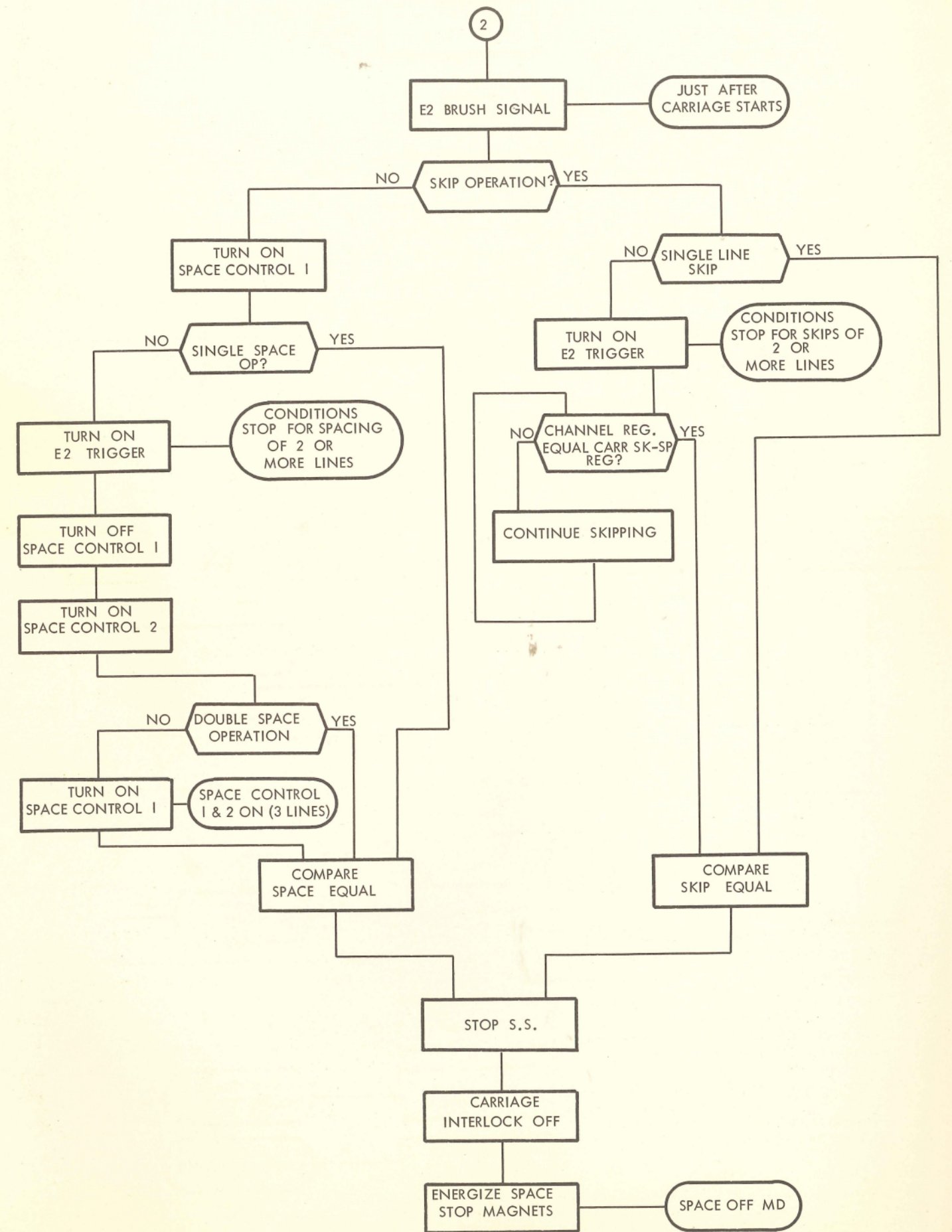



# CARRIAGE FAILURE SERVICE HINTS

## S.H. 1 FORMS TRACTOR

Forms tractor drive belt should have proper tension. Upper tractor pins should touch top edge of paper hole, while bottom tractor pins should touch bottom edge of paper hole. No elongation should occur when moving paper manually with paper advance knob. Slight amount of elongation is permissible under power. Refer to I403 reference manual for adjustment procedures of belt tension and tractor shaft positioning. Be sure no binds exist when manually turning the advance knob in neutral.

## S.H. 2 HYDRAULIC DRIVE

Hydraulic drive belt should have 1/8" to 5/32" deflection half way between the drive motor and eject pump, use force of 1 lb. or 450 grams. Check for broken strands.

## S.H. 3 EMITTER BRUSH

- A. Emitter Brush Short strands on EI brush will allow the EI impulse to lengthen out as shown and cause a critical timing condition between EI and the respective stop brushes.

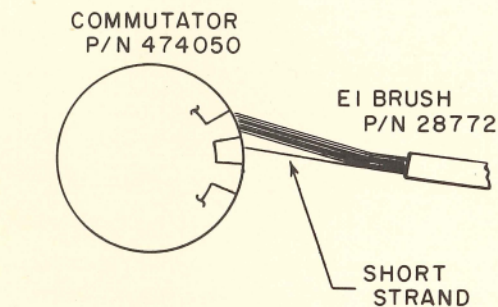

EI WAVEFORM

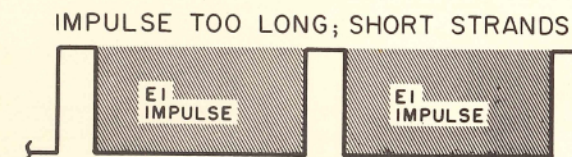

EI WAVEFORM

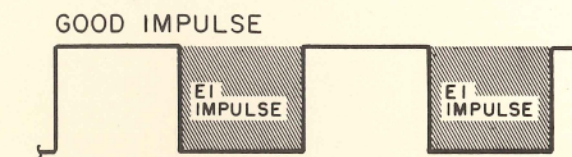

- B. Scope EI at test hub.  
 1) Put IBM card under carriage brushes.  
 2) Depress the restore key. This puts the carriage in a continual low speed skip.
- C. EI impulse should be fairly clean of noise. Dirty or worn brush or dirty emitter roll will cause distorted waveform. Crocus cloth can be used to clean roll. The emitter roll should always be cleaned when replacing the EI brush or common brush. Clean roll with tape cleaner after cleaning with crocus cloth.
- D. Check brushes for proper tension. Set EI brushes for  $23/32" \pm 1/64$  projection beyond the brush holder. EI brush timing should be checked whenever the brush is replaced. Refer to S.H. I2D or I3C

## S.H. 4 HYDRAULIC CARRIAGE

The hydraulic carriage waveforms should be checked during PM (Refer to S.H. I2, I3.) This will enable the CE to become familiar with the adjustment procedures.

## S.H. 5 VALVE BLOCK ASSEMBLY

The hydraulic unit is reliable. Do not attempt to dismantle the hydraulic unit unless the trouble is positively traced there. If dismantled, use extreme care and cleanliness when reassembling. To alter magnet armature clearances and spool valve adjustments, the valve block assembly has to be removed from the hydraulic unit. Armature clearances may be checked without removing assembly. Check magnet assemblies for worn or binding pivots. A fast method to remove the assembly is explained in S.H. I5 and I6. The method in the I403 Reference Manual can also be used, which removes the reservoir.

## S.H. 6 ERRATIC CARRIAGE FAILURES

Carriage response can be checked by using the tach-generator. Tractor shaft should start moving 3-4 m.s. after the start impulse and begin to slow down 3-4 m.s. after the stop impulse. If failures still exist and carriage waveforms can not be corrected by adjustment, the following should be checked:

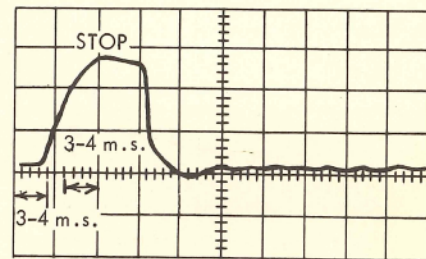

- A. Check -60V for low voltage and loose terminals.  
 B. Check space and skip magnet coils. Each has two coils in parallel. If one is open or has incorrect resistance, poor carriage response can result. Check magnet assemblies for worn or binding pivots.  
 C. Hydraulic Carriage Speed  
 To check the speed of the hydraulic carriage perform the following:  
 1) Punch one holes in carriage tape, 1 inch apart.  
 2) Program F B bit 2 444 in location 444. (This allows the carriage to run continually in low speed.)  
 3) Run program. Scope the "-T stop brush I" output. Sync internal, negative. Test point is located on the point of printer. The output should be 28.6 m.s. to 30.3 m.s. per in. (33-35 in. per sec.) This is measured from leading edge to leading edge.  
 4) The following can be the cause of slow carriage movement:  
 a. Hydraulic filter clogged. NOTE: The filter should only be changed when trouble is suspected not on a P.M. basis.  
 b. Check valve. See S.H. II.  
 c. Hydraulic fluid leakage within the unit.  
 d. Spool valve adjustments.  
 e. Bind in hydraulic unit.
- D. Bent shaft on the hydraulic unit can cause erratic spacing.  
 E. Loose AC cable to I403 can be the source of erratic carriage behavior.  
 F. Erratic carriage movement can also be caused by I403 fuse #9 being blown. This causes an open circuit to the high speed stop magnet.  
 G. An interruption of the -20V can cause unexplained carriage failures. Check HD-3 points in the I402 for bounce or burned points. Forms cart not grounded can also cause unexplained carriage failures.  
 H. Incorrect start and stop magnet armature to core clearance may cause the carriage to escape when power is turned off. This is due to the start magnet overriding the stop magnet momentarily. Refer to I403 Reference Manual for adjustment procedure.

- J. The following are B/M's available that correct certain machine problems:

- Prevent premature turn off of the high speed skip trigger.  
 I40I 25,000 Series EC CEM 569
- Improve single line skip and no line skip.  
 I40I 25,000 Series EC CEM 568  
 I40I 20,000 Series EC CEM 46I
- Desensitize 70 usec. single shot.  
 I40I 25,000 Series EC CEM 567  
 I40I 10,000 Series EC CEM 5I4
- Eliminate carriage restore failure.  
 I40I 25,000 Series EC CEM 498  
 I40I 20,000 Series EC CEM 382  
 I40I 10,000 Series EC CEM 460
- Prevent erroneous carriage movement when power is turned off. The ground return wire on the terminal block (TB2 in the Hydraulic unit) is split.  
 I403 CEM 489
- Eliminate sync checks and failure to space after print when stop key is depressed.  
 I40I 25,000 Series EC CEM 480  
 I40I 10,000 Series EC CEM 488
- Prevent reset of space skip register when changing forms.  
 I40I 20,000 Series EC CEM 25I

## S.H. 7 I403 HYDRAULIC UNIT REASSEMBLY

Any time the Hydraulic Unit is dis-assembled and the Channel Plate Assembly is separated from the Reservoir Mounting Plate, it will be necessary to readjust the input shaft of each pump and the output shaft of the Hydraulic Motor, upon reassembly. Aligning Tool, P/N 450980, is required for re-alignment of the Hydraulic Motor Output Shaft. This tool is available on a loan basis from any Parts Center. Place the Aligning Tool, P/N 450980, around the output shaft of the motor and over the base on the Reservoir Mounting Plate as shown.

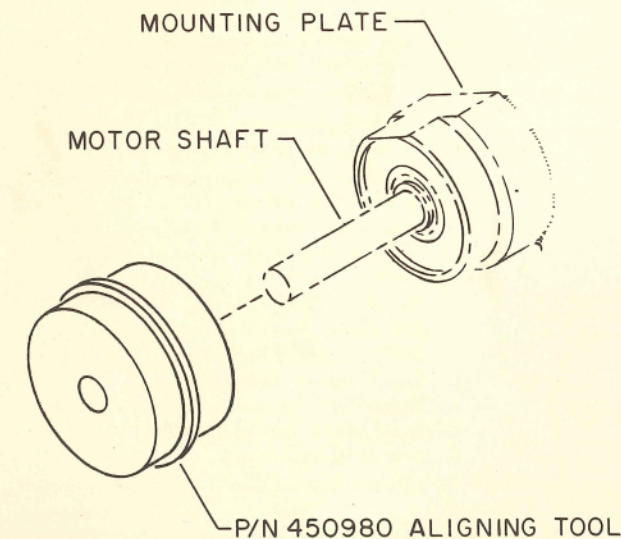

## S.H. 8 CARRIAGE FAILING TO MOVE

Carriage failing to move can be caused by a broken valve stem. The stem falls out of the cylinder which causes the fluid to bypass the hydraulic motor.

## S.H. 9 BELT - YOKE

The forms tractor belt yoke assembly can be replaced without replacing the complete belt assembly. This method can be used when the yokes are broken and the belt is not worn.

## S.H. 10 CARRIAGE SYNC POINTS

Reference can be made to d Character Chart when programming from control op.

d Immediate skip to	d Skip after print to
1 Channel 1	A Channel 1
2 Channel 2	B Channel 2
3 Channel 3	C Channel 3
4 Channel 4	D Channel 4
5 Channel 5	E Channel 5
6 Channel 6	F Channel 6
7 Channel 7	G Channel 7
8 Channel 8	H Channel 8
9 Channel 9	I Channel 9
0 Channel 10	+ Channel 10
# Channel 11	. Channel 11
@ Channel 12	□ Channel 12
d Immediate space	d After print-space
J 1 space	/ 1 space
K 2 spaces	S 2 spaces
L 3 spaces	T 3 spaces
Y - Space Suppress	

d- CHARACTER FOR FORMS CONTROL

- The output of the carriage op. register can be used as a sync point to check skip before or space before print operations. After space control can be used as a sync point to check space and skip after printing.
- Sync on tu space skip gate to check setup of the space skip register and the carriage op. register on any programmed space or skip operation.
- Sync on-T not start single shot going positive to check the space counter.
- Sync on any of the -T stop brush signals to check the channel brush encoder and the setup of the channel register.
- The following is a list of sync points and ALD pages:
 

	Stage I	Stage II & IFC
After Space Control	36.47.11.1	36.47.11.2
Carriage OP. Register	36.46.11.1	36.46.11.2
Space/Skip Register	36.42.11.1	36.44.11.2
Not Start Single Shot	36.44.11.1	36.47.11.2
Space Counter	36.44.11.1	36.46.21.2
Stop Brush	36.45.11.1	36.42.21.2
Brush Encoder	36.45.21.1	36.42.11.2
Carriage Channel Register	36.45.31.1	36.43.11.2
Carriage Channel Register	36.46.11.1	36.43.31.2
Space/Skip Gate	36.42.11.1	36.46.11.2

## S.H. 11 CHECK VALVES

Refer to "OIL FLOW SCHEMATIC," Page I6.

- The purpose of the lower check valve is to prevent fluid from the space pump escaping into the skip pump return circuit when the skip stop magnet is energized.
- A defective lower check valve (mounted horizontally in hydraulic unit) will cause slow carriage operation and poor waveform response when checking the hydraulic unit with a tach generator.
- The upper check valve (mounted vertical in hydraulic unit) stops nipping when the carriage transfers from high to low speed.
- A defective upper check valve will cause the detent arm spring to break. Print alignment is not usually affected by a faulty upper check valve.

S.H. 11 CHECK VALVES (continued)

3) The upper and lower check valves are interchangeable. The valves can be interchanged to aid in trouble shooting when trouble is suspected in this area and none are available.

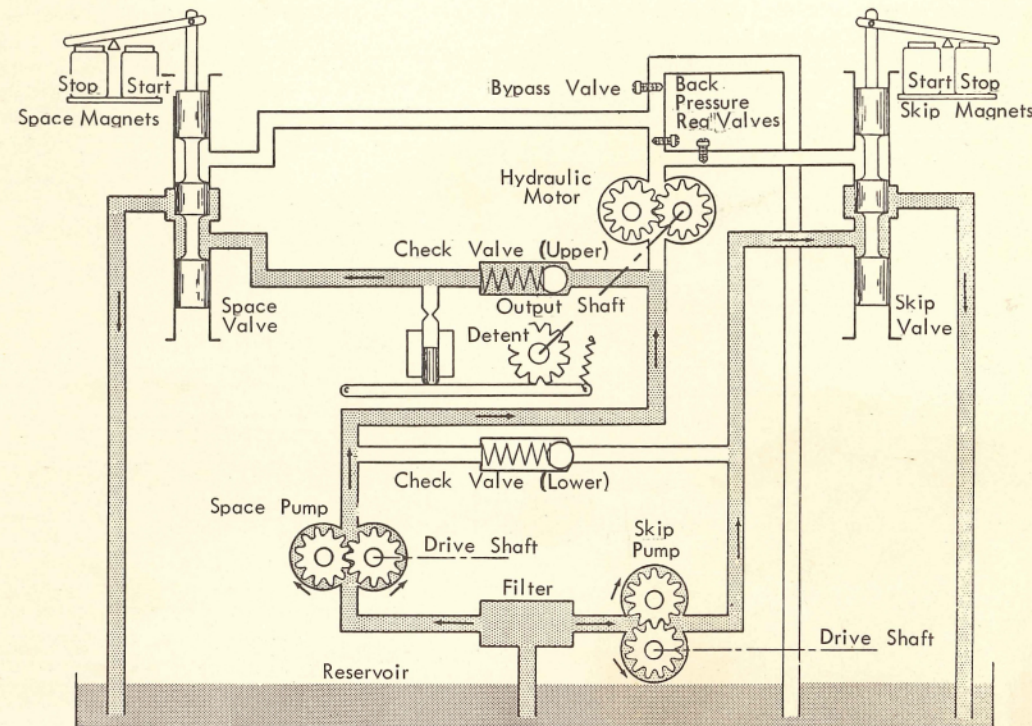

OIL FLOW SCHEMATIC

S.H. 12 CARRIAGE ADJUSTMENT - DASH METHOD

The dash method can be used as a quick way to check the 4.5 M.S. single shot, the EI emitter and bypass needle valve. For a more accurate method in checking and adjusting the hydraulic unit, the use of the tach generator is recommended. The space and skip needle valves should be checked last. Checking these valves involves removing the cover and actually making adjustment. If an adjustment is made to the hydraulic unit, all other adjustments should be checked. Before proceeding with the following adjustments, the hydraulic unit must be hot. Block the blower input with an IBM Card and put the hydraulic unit in a continuous low speed skip to accelerate the heating of the unit. (Min. 15 minutes) The C.E. will have to feel the unit to determine when it is hot. All adjustments must be made in 6 line drive.

A. SPACE NEEDLE VALVE ADJUSTMENT

Before making any adjustments, mark the screwdriver slots with a pencil so that you will know where the needle valves were, before adjustments are made. Loosen the locking screw just enough so that the adjusting screw turns hard when making the adjustment.

1. Remove the top cover from the hydraulic unit.
2. Remove the forms and insert an IBM card in the tractor to operate the form stop switch.
3. Back the Bypass (BP) needle valve out several turns (loosen locking screws).
4. Put the carriage in a continuous low speed skip. To do this, put a blank IBM card under the carriage brushes and depress the carriage

restore key.

5. Loosen the locking screw on the space needle valve. Hold fingers lightly against the detent arm and turn the space needle valve out several turns. Now turn the space needle valve clockwise until detent nipping is no longer felt and the detent is up against the backstop. Watch the tail of the detent for nipping, then to a floating condition, and finally just up against the backstop. Note the difference between machine vibration and nipping. The tail of the detent should have a movement of .040" to .050" if the backstop is adjusted properly.

NOTE: After tightening any needle valve locking screw, check that the adjusting screw does not turn.

- 6) Put the carriage in a high speed skip by programming F I . Adjust the skip needle valve for the same no nip condition as was done for the space needle valve. Tighten the skip needle valve locking screw. If no nipping is detected after turning out a maximum of five turns, stop the carriage motor by turning off the mainline switch on the back of the printer so that the hydraulic pumps are not moving. Turn down on the skip needle valve until it is closed. Then back off five full turns on this screw. Tighten the locking screw.

B. BYPASS NEEDLE VALVE ADJUSTMENT

Insert forms into the machine and program for a triple space before print, 6 lines to the inch, with dashes in the print area (B bits) FT 2444 at location 444. Put the card on an extender that is indicated in the chart in section C of this service hint to allow printing in flight. By printing dashes the printer will draw an accurate graph of carriage movement. Start the program running and hold down on the detent arm to hold it out of the detent wheel. Adjust the bypass valve for hydraulic stop without bounce. With the BP valve backed out, there should be no hydraulic stop as in Fig. 1. Turn the BP valve in until hydraulic bounce occurs as in Fig. 2. Back out on the valve to the point of no bounce as in Fig. 3. When properly adjusted, the triple spaced line will look like Fig. 3.

FIGURE 1 BP VALVE OUT TOO FAR - NO HYDRAULIC STOP

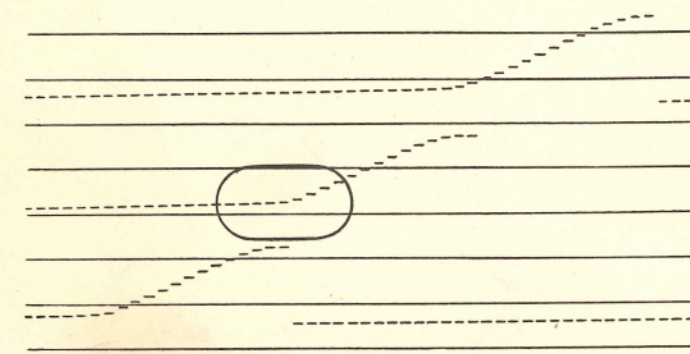

FIGURE 2 BP VALVE IN TOO FAR - NOTE HEAVY OVERSHOOT

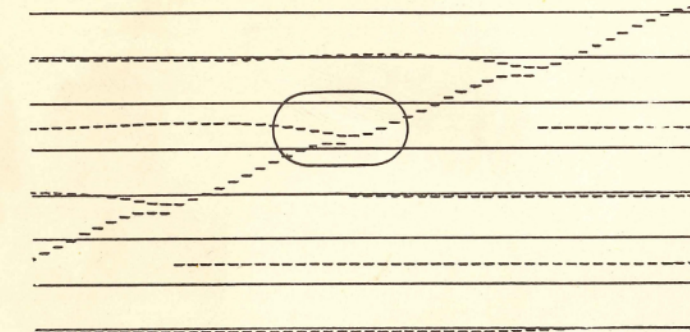
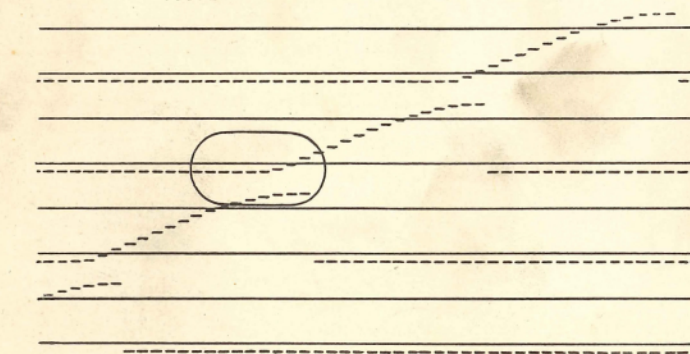

FIGURE 3 PROPER BP VALVE - NOTE LEVEL PRINTING BEFORE DRIFT



C. A QUICK CARRIAGE ADJUSTMENT CHECK FOR SINGLE SPACE.

Program a single space print loop (2444 at location 444), 6 lines to the inch, with dashes (B bits) throughout the print area.

To allow printing in flight, the 16 millisecond single shot and the -T not carriage interlock lines need to be floated. To accomplish this use the following chart:

1401	Card to be extended	Pin to be removed	Logic pg.
10,000 series	01A6 D02	P	36.31.21.1
20,000 series	01A6 B08	G	36.31.31.2
25,000 series	01A6 B08	G	36.31.31.2

These points are the extender input to the And circuit that feeds the reset gate on the print ready trigger. Adjust the 4.5 millisecond single shot so that the carriage settles down as soon as possible. Least number of dashes before line levels off. Refer to figures 4, 5, and 6. The purpose of this adjustment is to time the electrical stop of the carriage so that when it stops, the detent is in the tooth of the detent wheel. This will allow the carriage to settle as soon as possible, with no motion resulting from the detent.

FIGURE 4 4.5 MS SS TOO SHORT - NOTE DETENT PULL IN

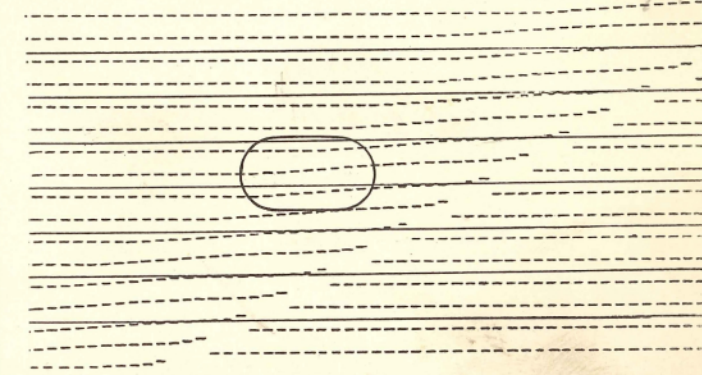

FIGURE 5 4.5 MS SS TOO LONG - NOTE OVERSHOOT

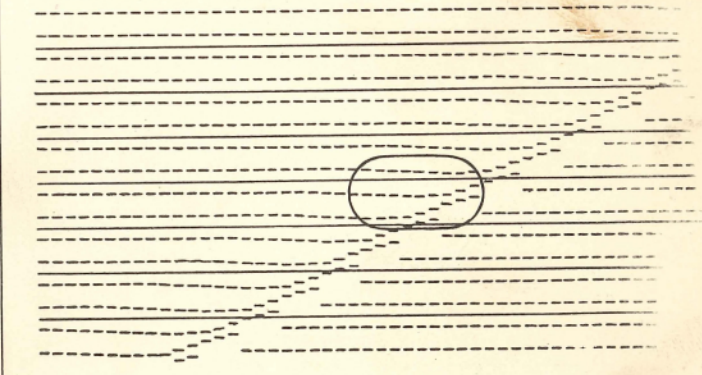
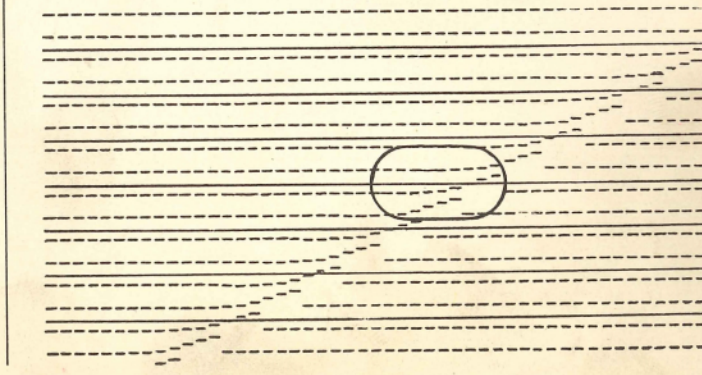

FIGURE 6 4.5 MS SS CORRECT - NOTE SLIGHT OVERSHOOT



#### D. EMITTER ADJUSTMENT

When double or triple spacing or skipping the emitter controls the stopping of the carriage. Therefore the emitter must be timed to the detent, as the 4.5 milli-second single shot was.

Program a triple space before print, six lines to the inch, and print all dashes (FT 2444). The 16 milli-second single shot and -T not carriage interlock lines need to be floated as per the chart in section C of this service hint.

Check for proper brush tension and short strands before adjusting the brush type emitter. Refer to S.H. 3. Adjust timing of the emitter brush so carriage motion stops as soon as possible. Least number of dashes before line levels off. See figures 7, 8, and 9.

The final setting of the emitter adjusting arm should be a compromise between slight pull in at 8 lines per inch double space and slight overshoot at 6 lines per inch triple space.

Better scope pictures are available in the 1401 after the integrator card than from the two test hubs on the 1403.

FIGURE 7  
EMITTER BRUSH EARLY- NOTE DETENT PULL IN

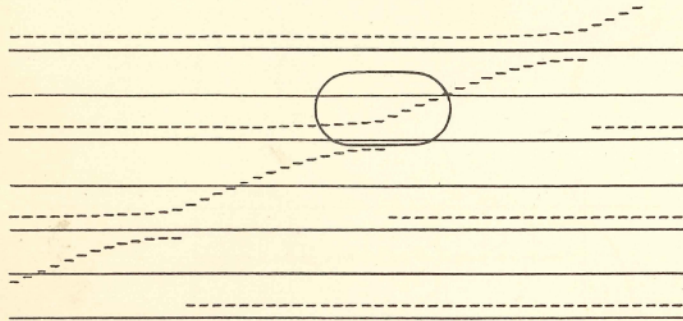

FIGURE 8  
EMITTER BRUSH LATE- NOTE OVER SHOOT

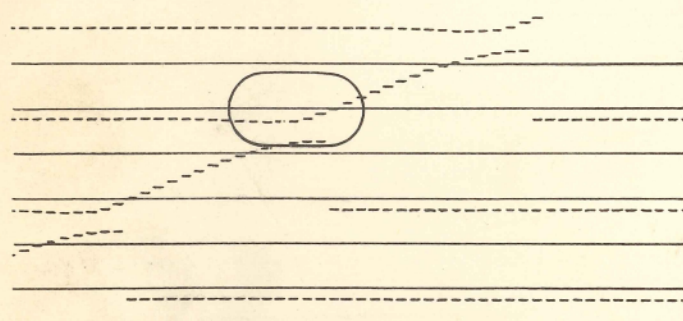
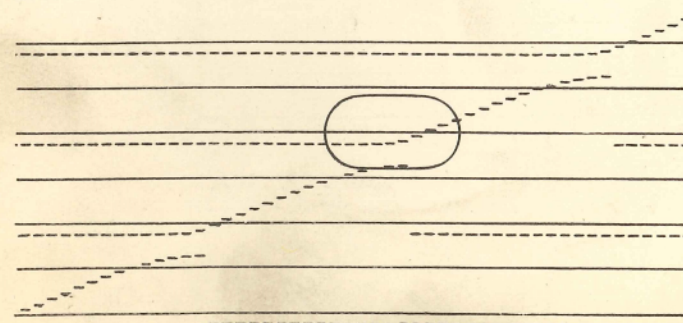

FIGURE 9  
EMITTER BRUSH TIMED CORRECTLY



#### E. CARRIAGE TAPE SPROCKET ADJUSTMENT

Before timing the sprocket, check the carriage tape transport mechanisms. The brush separator should be  $.050'' \pm .010''$  from the contact rolls. Contact rolls must turn free.

Be sure that no binds exist when you manually turn the forms advance knob with the 6-8 knob in neutral. Drive sprocket must be in line with contact rolls to prevent carriage tape skew. A collar is provided to maintain alignment of sprocket. Rapid wear of the carriage tape sprocket holes indicates the tape transport is out of adjustment or the sprocket is cracked. 1403's prior to A2 suffix have a narrow tape drive sprocket. If difficulty is experienced in feeding carriage tapes, installation of the wider sprocket, Part #474019, will assist in increasing the life of carriage tapes.

Carriage brush timing should be adjusted with a new carriage tape as follows: Tape should be punched on customer's carriage tape punch.

NOTE: In low speed, the carriage stop brush should make 1 millisecond  $\pm 1/4$  before the emitter brush. If machine has a magnetic emitter, the carriage stop brush should make 1.5 milliseconds  $\pm 1/4$ , -0 before the emitter pulse. Note all 12 channels stop brushes must meet this timing relationship to EI. Break of EI should not overlap the stop brush break. Refer to S.H. 3 for brush type EI.

1. Insert a carriage tape with a channel one punched on every third line. Remove forms and insert IBM cards to actuate the forms check switches. Engage the clutch in 6 line drive. Program a space to zero (no numeric bits) before print. F B bit 2 444 at 444. Clear the print area to C bits. This will put the carriage into a low speed skip.
2. Sync the scope on "-T Stop Brush 1" and look at "-T Emitter brush". These test points are located on the front of the printer. Loosen the shaft expansion screw and rotate the tape drive sprocket with respect to its shaft to obtain the proper timing. To increase expansion of shaft for any given screw torque, apply a small amount of IBM 70 Lubricant to taper surface of the screw. Tighten the shaft expansion screw with the 10" screwdriver. Be certain the screw does not bottom. Whenever tape drive sprocket is changed for brush timing, check alignment of tape to contact roll shoulders. The tape guide bracket must not project above drive sprocket at any point or it will lift tape up on pins, causing accelerated tape wear and skipping problems.

#### F. 16 MILLISECOND INTERLOCK SINGLE SHOT TIMING

Re-install card previously put on an extender to restore machine to proper operation.

Subtract the timing of the 4.5 m.s. single shot from 21.4, which is the maximum time allowed for spacing (actually it is 21.6 but use 21.4 for safety). Sync on start and set 16 m.s. s.s. to time out 21.4 m.s. from start of sweep. Measure single shot timing at mid-point of waveform. Since the 4.5 m.s. s.s. may be over 5 m.s. for proper operation the 16 m.s. s.s. may be less than 16 m.s. The sum of the two must add to 21.4 m.s. The 10m.s. single shot should be adjusted to 1.7 m.s. less than the 16 m.s. single shot. Sync on start and set 10 m.s. s.s. to time out 19.7 m.s. from start of sweep.

#### S.H. 13 CARRIAGE-SERVICE INFORMATION AND USE OF TACH-GENERATOR- IBM 1403

Service Aid: The Hydraulic Unit should not be dismantled unless trouble is positively traced to this area. If disassembly is necessary, extreme cleanliness must be observed when re-assembling components. Never wipe the fluid filter with cloth of any type. The filter pores will clog, reducing fluid

pressure and cause carriage failures. A spare Reservoir Gasket Assembly, P/N 444337, should be available prior to disassembly of this unit.

The Tach-Generator is used to convert the mechanical motion of the carriage into an electrical output for scoping purposes and is the most accurate method of checking the Hydraulic Unit.

Before using the Tach-Generator, check adjustments of space and skip needle valves as outlined in S.H. 12.

#### TACH-GENERATOR AND SCOPE CONNECTIONS

1. Connect 1.0 MFD, 200 volt capacitor, P/N 253826, across Tach-Generator output terminals.
2. Remove Paper Advance Knob, from upper Tractor Drive Shaft. Install Tach-Generator and coupling on shaft as shown, and tighten set screw.

UPPER TRACTOR DRIVE SHAFT ASM.

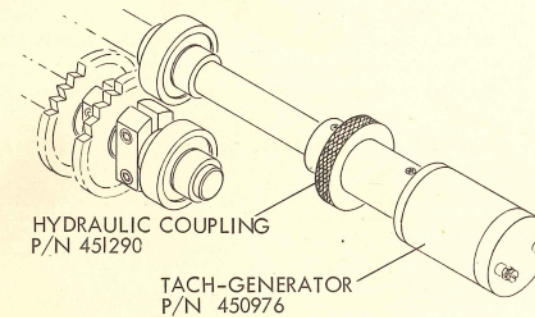

3. Ground the scope and connect vertical input and scope ground to Tach-Generator terminals.
4. Sync scope on impulse to space start magnet, terminal 2, Resistor 4, Logic Page 02.01.1 Resistor 4 is mounted on heat sink behind hydraulic unit. R4 is the fourth resistor down and Terminal 2 is on the right side of resistor facing rear of machine. If a dual input scope is available, use impulse to space stop magnet Terminal 2, Resistor 3, as second input to scope. On single input scopes, two signals may be examined separately in relation to start magnet impulse.

NOTE: A defective capacitor or one of incorrect rating, will alter Tach-Generator output trace on scope. Capacitor should remove high frequency oscillation from scope trace without affecting pulse timing. Check by noting pulse timing with capacitor in and out of circuit.

#### A. ADJUST THE BY-PASS NEEDLE VALVE

Before proceeding with the following adjustments, Hydraulic Unit must be hot. Block the blower input with an IBM card and put the hydraulic unit in a continuous low speed skip to accelerate the heating of the unit. (Min. 15 minutes) The C.E. will have to feel the unit to determine when it is hot. All adjustments must be made in 6 line drive. Note: Carriage response time should be 3-4 m.s. when starting and stopping.

1. Set up program for triple space loop with C bits in the print area. Example: 2 F444T at location 444.
2. Engage manual clutch in six lines-per-inch position.
3. Loosen Bypass Needle Valve Lock Screw just enough to permit adjusting needle valve.
4. Disengage detent arm by pressing down in the notch, with a large screwdriver.
5. Block Forms Switches and run printer program, observing the scope. (No paper required).
6. Adjust bypass needle valve for scope trace down in Fig. 11. Back bypass valve screw off 1/12 turn. Tighten bypass lock screw. Double check adjustment by making pencil trace, shown in Fig. 11. Combination scope trace indicating light hydraulic bounce and pencil trace of rel-

atively square corner followed by carriage drift verifies correct bypass adjustment. Important: As little as 1/4 turn from correct setting for bypass needle valve can produce incorrect scope and pencil trace, as shown in Figure 10 and Figure 12.

The pencil trace is the most accurate method of checking the bypass needle valve adjustment. It should be used along with the tach-generator method.

FIG. 10 BY-PASS ADJUSTED TOO LOOSE (1/4 TURN)

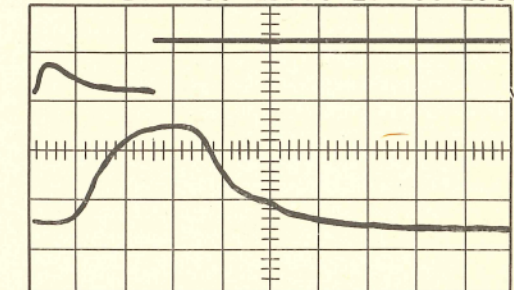

NO HYDRAULIC STOP

FIG. 11 BY-PASS ADJUSTED CORRECTLY

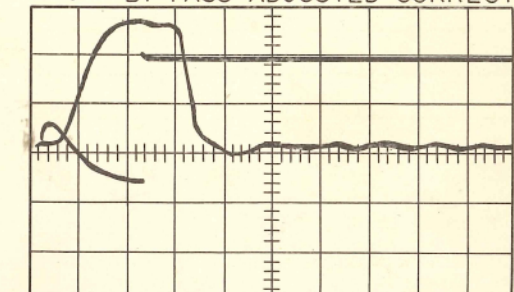

POWER TRIPLE SPACE

HYDRAULIC STOP

CARRIAGE DRIFT

FIG. 12 BY-PASS ADJUSTED TOO TIGHT (1/4 TURN)

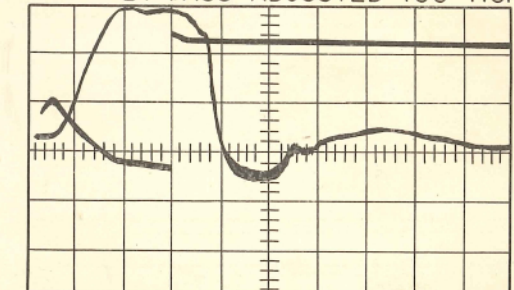

(2V/CM) (5MS/CM)

HEAVY HYDRAULIC BOUNCE

Single Shot Timing for 600 Lines Per Minute

NOTE: The 1403 must be capable of printing 600 lines per minute using a print and branch instruction. It must print, move paper, and be ready to print again in 100 milliseconds. The carriage start magnet is impulsed at beginning of 48th print scan. 21.6 milliseconds is the maximum allowable time from beginning of scan 48 (paper movement) until scan of the next line is initiated.

B. SINGLE SPACE TIMING SEQUENCE

1. Start of scan 48 impulsed the carriage start magnet and "4.5 millisecond" single shot simultaneously.
2. When "4.5 Millisecond" single shot times out the space stop magnet and the 16 MS single shot are impulsed simultaneously.
3. A PSS pulse coincident with PSS Ring 3 after the 16 MS single shot times out signals start of next line of print. The Sum of the "4.5 millisecond" single shot and the "16 millisecond" single shot settings must not exceed 21.6 to insure 600 lines of print per minute. To be safe, use 21.4 milliseconds.

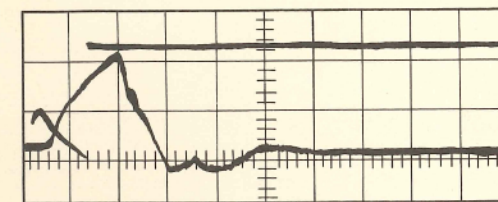
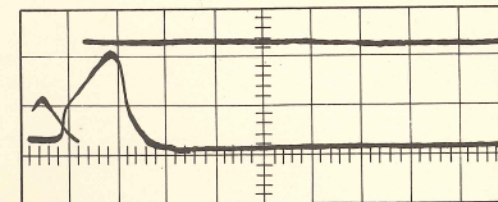
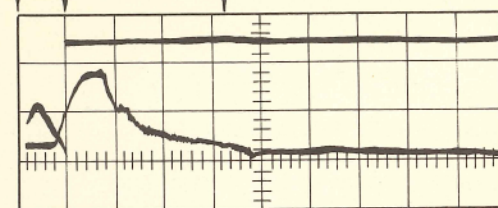
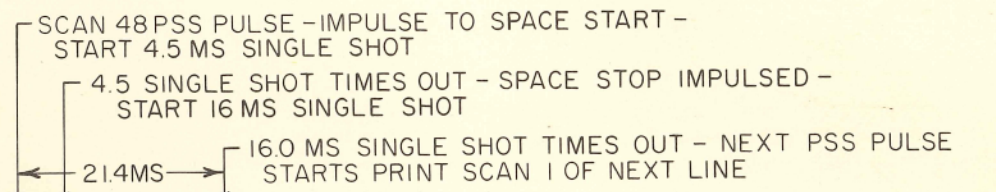

FIG. 13 SINGLE SPACE - 6 LINES PER INCH ADJUSTMENTS OF THE 4.5 MS SINGLE SHOT

ADJUST SINGLE SPACE SINGLE SHOT

1. Set up program for single space loop at six lines per inch with dashes throughout print area. Example: 2 444 in Location 444.
2. Initially set 16 millisecond single shot to 16 milliseconds.
3. Adjust 4.5 millisecond single shot for minimum time from start of trace (carriage space start impulse) until scope pattern indicates tractor shaft movement has settled down. (Figure 13)
4. Sync on start and set 16 m.s. s.s. to time out 21.4 m.s. from start of sweep.
5. Sync on start and set 10 m.s. s.s. to time out 19.7 m.s. from start of sweep.

NOTE: The end of 16 millisecond single shot trace should be measured at the midpoint of the negative going pulse. Now check the alignment with dashes, (single space, 2 444 ). Sight along line of print to observe alignment. Record settings of each single shot on the logics for future reference.

C. ADJUST THE EMITTER (EI BRUSH OR MAGNETIC EMITTER)

1. Set emitter brushes for projection beyond brush holder of 23/32" plus or minus 1/64".
2. Set up program for triple space loop at six lines per inch with dashes throughout print area. Sight along line of print to observe alignment. Example 2 F 444 T in location 444.
3. Run program and observe scope trace.
4. Shift emitter adjustment arm to obtain least time to settle tractor shaft movement shown in Fig. 14

NOTE: A pencil trace may indicate overshoot, pull-in, or square, but best print alignment occurs with adjustment 4. The emitter may also be rotated with respect to the shaft to obtain EI adjustment.

5. Change program to double space loop at eight lines per inch with dashes throughout print area. Example: 2 F 444S in Location 444.
6. Run program and observe scope trace.
7. Shift emitter adjustment arm to obtain least time to settle tractor shaft movement shown in Fig. 15

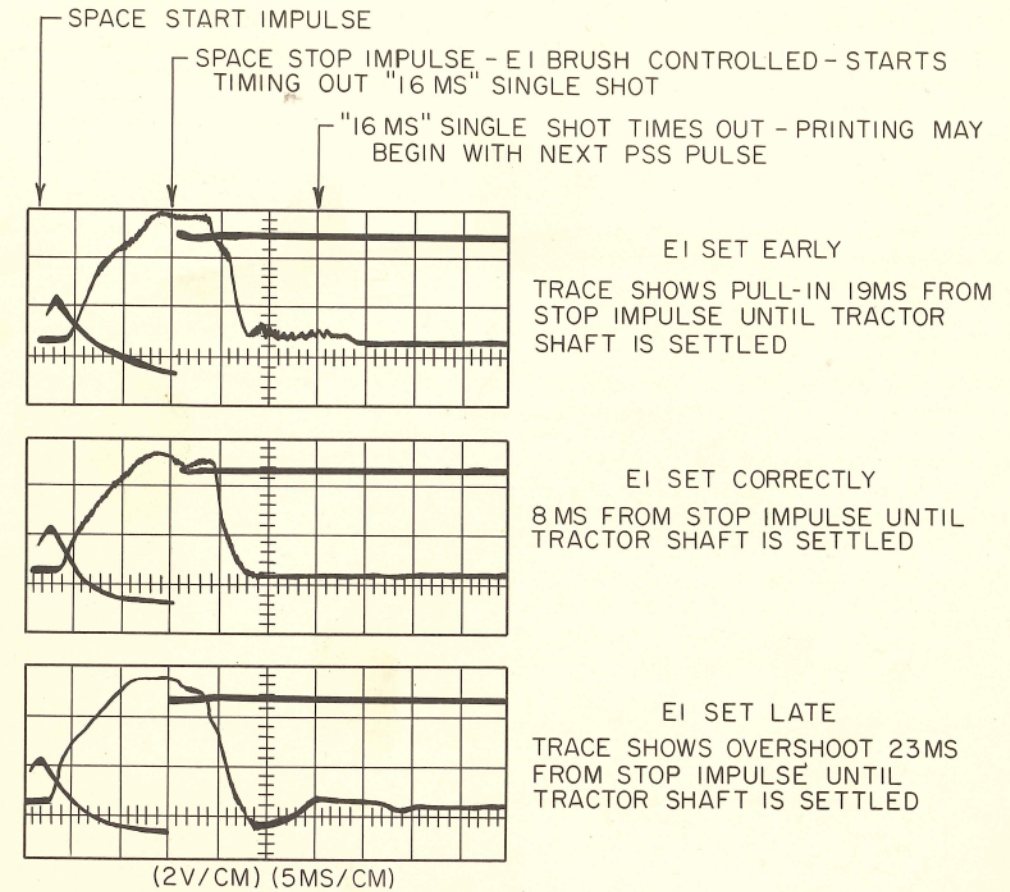

FIG. 14 EI BRUSH ADJUSTMENTS FOR TRIPLE SPACE 6 LINES PER INCH

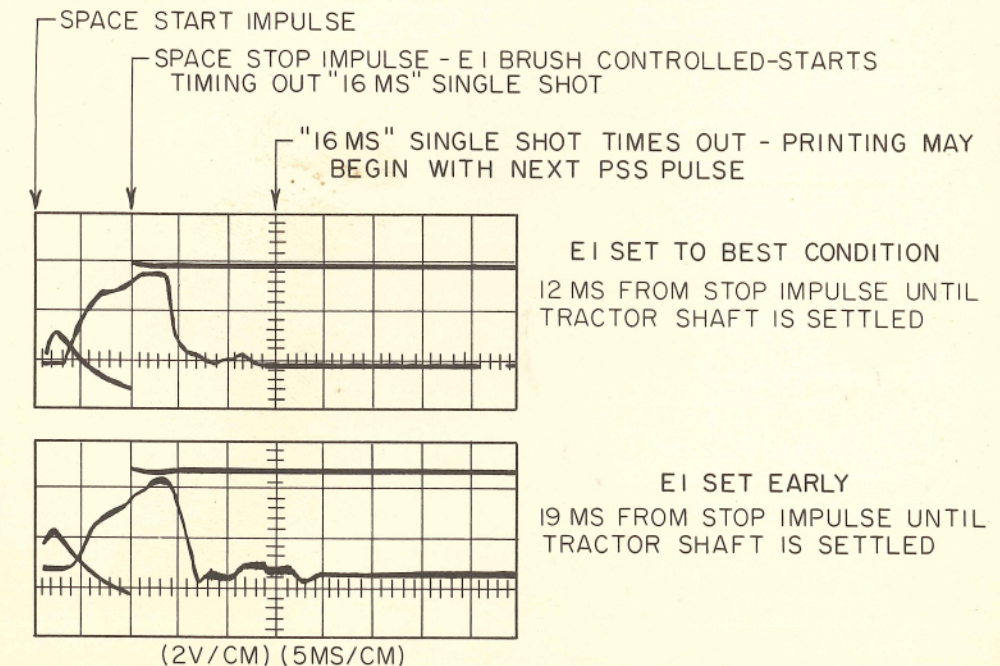
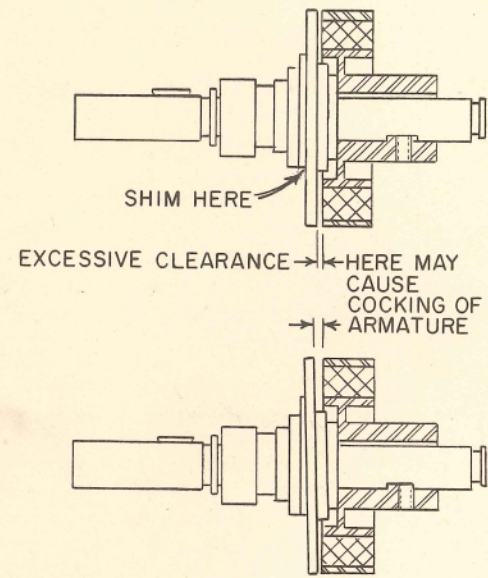

FIG. 15 EI BRUSH ADJUSTMENTS FOR DOUBLE SPACE 8 LINES PER INCH

**S.H. 37 RIBBON STALLING**

Ribbon stalling can result from excessive clearance between friction clutch armature plate and rotor surface. The armature will cock on its spline and fail to mate with the rotor surface when the clutch is energized. To obtain this clearance, one or more of the following shims must be inserted between the retaining ring and the armature as shown.



shim thickness	P/N
.010	233154
.016	204431
.025	204432

Clutch faces must be cleaned with crocus cloth.

If old style toothed ribbon feed clutches are in the machine, they should be replaced with the new style friction drive clutches. 1401 EC CEM 326 B/M 485406.

Some machines have been shipped which contain ribbon feed clutch armatures (P/N 475678) which were inadvertently polished. Machines containing such armatures may fail to transmit sufficient torque to overcome the brake drag, resulting in stalled ribbons and eventual ribbon damage. If this condition is noted, the armature P/N 475678 should be replaced.

**S.H. 38 REVERSE DRAG FRICTION RING**

Excessive drag on lower ribbon reverse drag friction rings can cause failure to correct ribbon skew or ribbon stalling. Ribbon skew is corrected only when the upper ribbon spool is winding. Under these conditions, ribbon tension can increase to a point where the skew roll cannot grip the ribbon. If this condition is evident, frictions rings should be inspected for oil, grease,

or debris and cleaned. Refer to Fig below

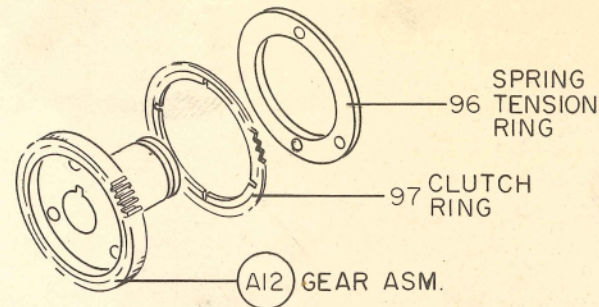

REFER TO 1403 PARTS CATALOG (FORM NO. 124-0026-2) REF. 16

**S.H. 39 RIBBON SKEW FAILURES**

Ribbon skew failures can be caused by the adjustment of the skew roll or the roll becoming soaked with ink and swelling. The skew roll should be replaced if it becomes soaked with ink. If no roll is available, the old one could be shaved down with a knife.

Ribbon skew can be caused by the ribbon becoming stretched on one side due to the printing all being done on that side. This will cause the ribbon to wind like a cone and cause skew. By periodically reversing the ribbon under these conditions, longer ribbon life will result. A defective spider spring, Part # 474159, or dirty friction disc, Part # 473651, can cause skew trouble.

Refer to the 1403 Reference Manual for ribbon skew adjustments.

**S.H. 40 RIBBON REVERSE FAILURE**

Failure of the ribbon to reverse can result if the toggle plate spring, P/N 473795, and the ribbon reverse lever spring, P/N 473796, are interchanged. The springs are easily identified, as P/N 473795 is black, while P/N 473796 is cadmium plated. Refer to Fig below.

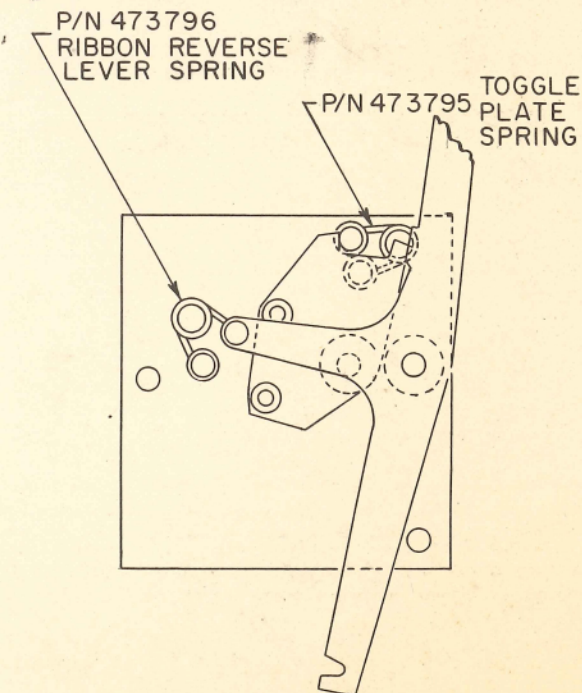

**FORMS STACKING TROUBLE**

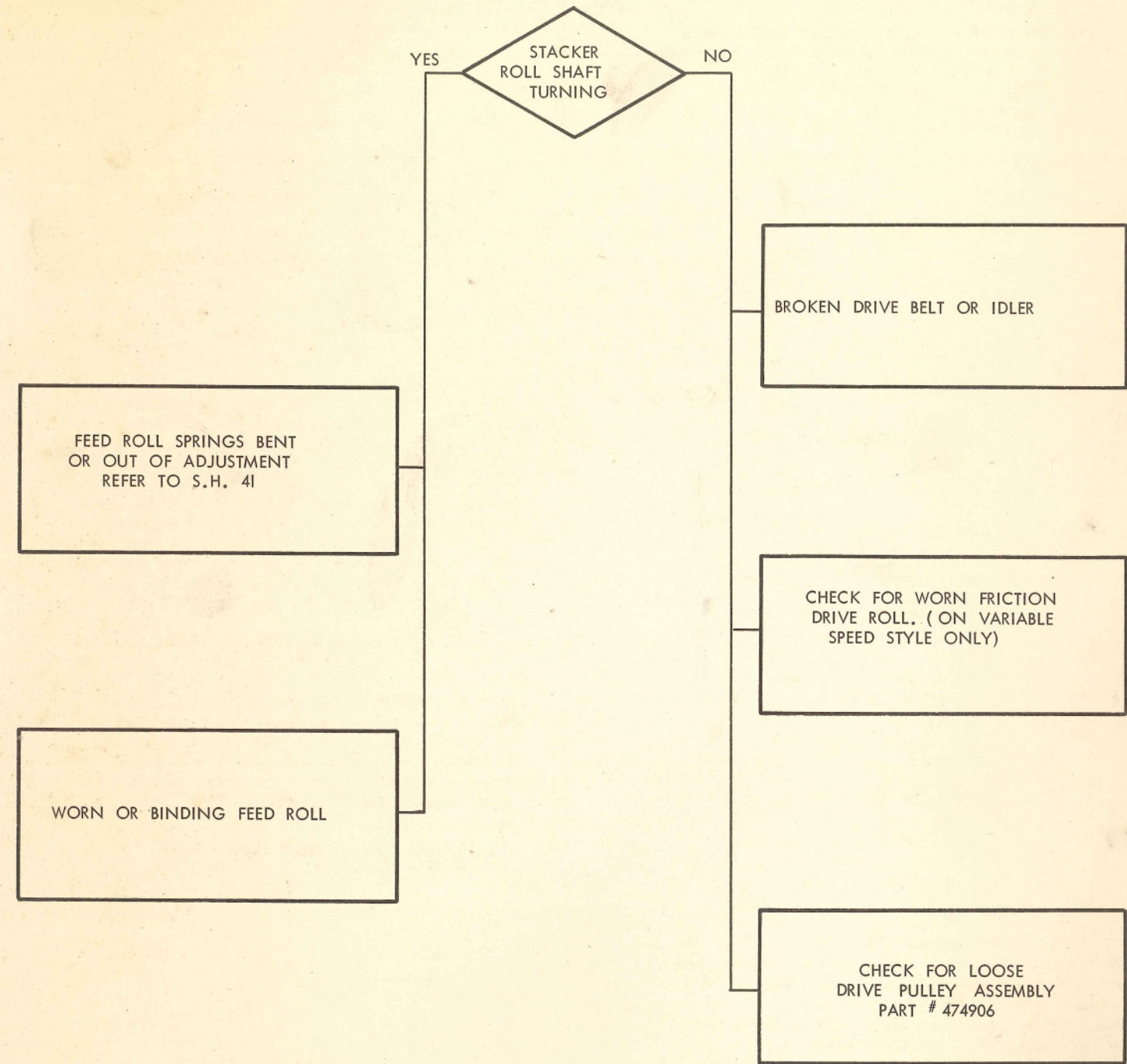

**S.H. 41 STACKER TENSION SPRINGS**

Stacker tension springs are to be adjusted to feed rolls to a point of tangency without compressing the springs.

This adjustment is made with the stacker spring lift bar in the drive position.

# 1401 OR PRINTER STOPS

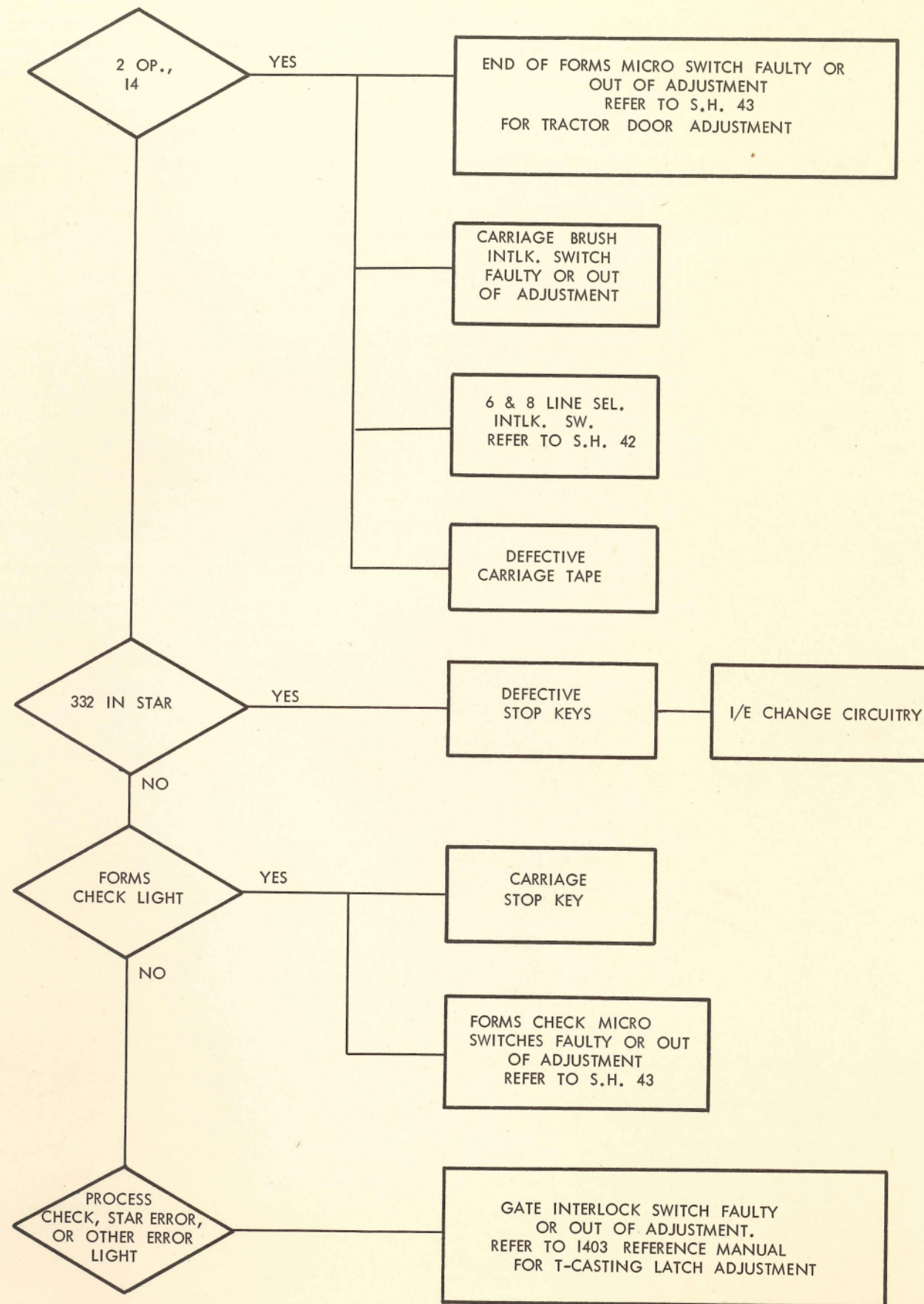

NOTE: ALL OF THE ABOVE INDICATIONS OCCURED WITH PRINT AND BRANCH LOOP.

## S.H. 42 INTERMITTENT 1403 STOPPING

Intermittent stopping of the 1403 can be caused by play in the selection knob or faulty 6-8 line micro-switch. The detents are held by four collars that slip if they are not properly tightened. Tighten the two end detent pivot shaft collars snug against the casting to prevent axial movement of the shaft. Set to 6 line drive and position the detents with their two collars to center the 6-8 line shaft rock over the switch actuating rod. Check in 8 line drive. 1401 EC CEM 314 provides larger collars containing two set screws.

## S.H. 43 FORM TRACTOR ADJUSTMENTS

The following is the procedure to use when adjusting the form tractor door and the jam detection device. Forms Tractor Adjustments- IBM 1403 Current production machines incorporate a jam detection micro-switch assembly mounted on each of the four forms tractors. Adjust the tractor doors and individual jam detection device as follows: Refer to Fig. 23

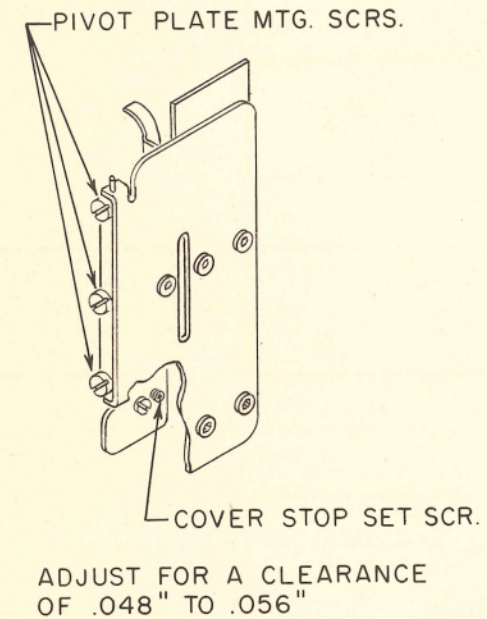

FIG. 23

1. To position the tractor door for a clearance of .048" to .056" to the paper guide.
  - a. Loosen the pivot plate mounting screws.
  - b. Turn the cover stop set screw in below the correct door setting.
  - c. Insert the necessary feeler gages.
  - d. Holding the door against the feeler gages, and tighten the pivot plate mounting screws.
  - e. Readjust the cover stop set screw to hold the door at the correct clearance.

2. Adjust the jam detection nyloc set screw for break of the jam detection switch with an additional door opening of .047" to .062". This will result in a door opening of .095" to .118" when the switch breaks. Refer to Fig. 24

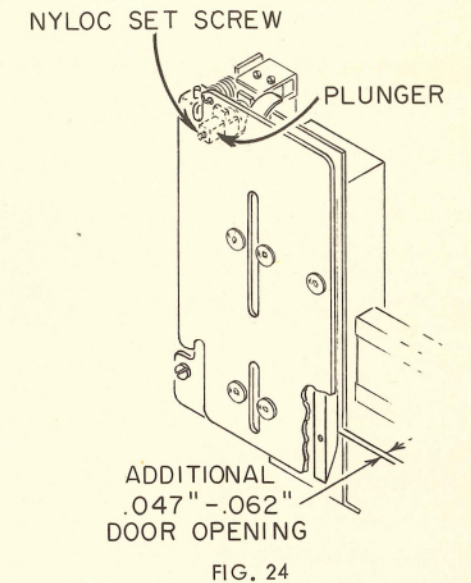

FIG. 24

3. Adjust the slide support to limit tractor door open position to obtain  $3/32 \pm 1/32$  clearance between the tractor door and straight edge held perpendicular to the tractor guide plate. The straight edge must be butted against the belt guide step as shown. Refer to Fig. 25

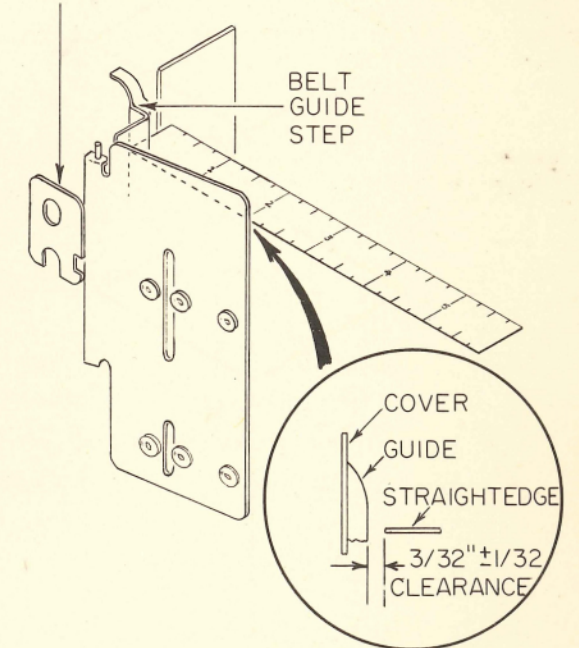
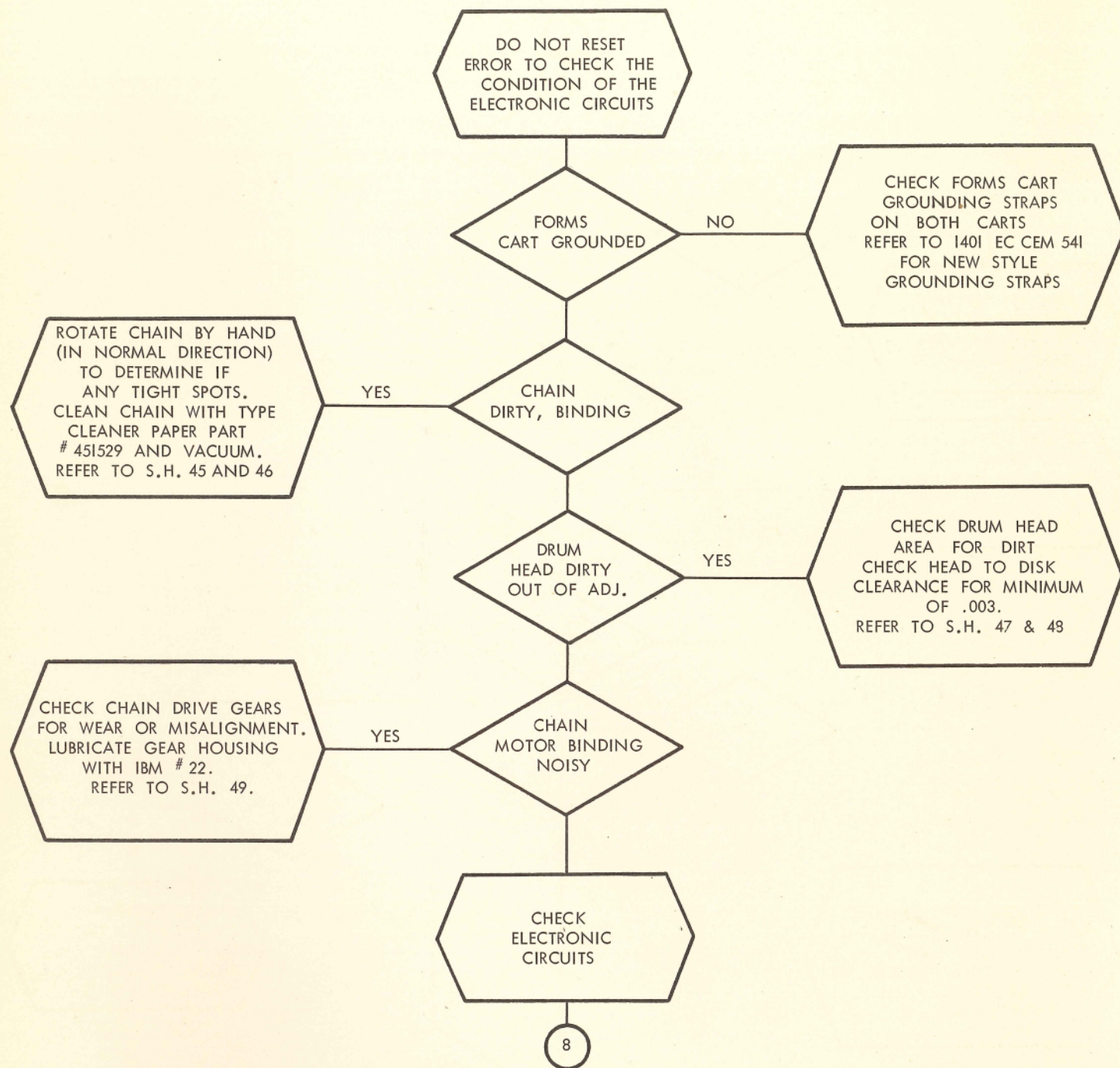

FIG. 25

Refer to 1403 Reference Manual (Tractor Jam Detection Device adj.) if the 1403 has the Jam Bar Bail style.

# SYNC CHECKS



S.H. 44 SYNC AND PRINT CHECKS  
If getting print and sync checks together, try trouble shooting the sync checks first.

S.H. 45 CHAIN OILER ADJUSTMENT  
Adjust lubricator chamois to just touch a straight edge laid along the back side of the center bar, or with straight edge removed, chamois must not protrude above center bar assembly more than 1/64".

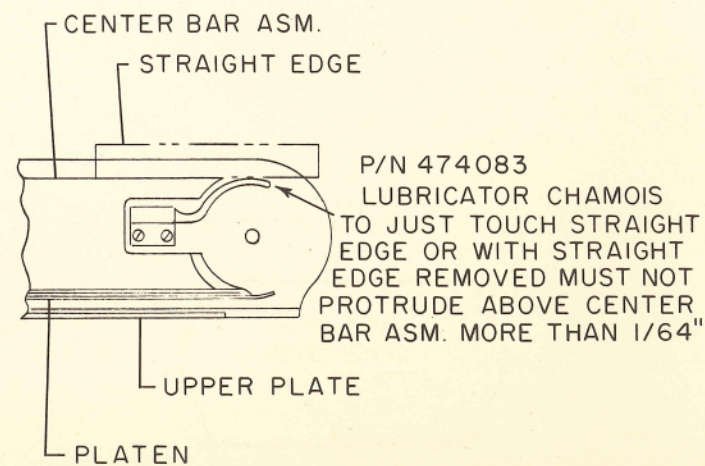

# SYNC CHECKS

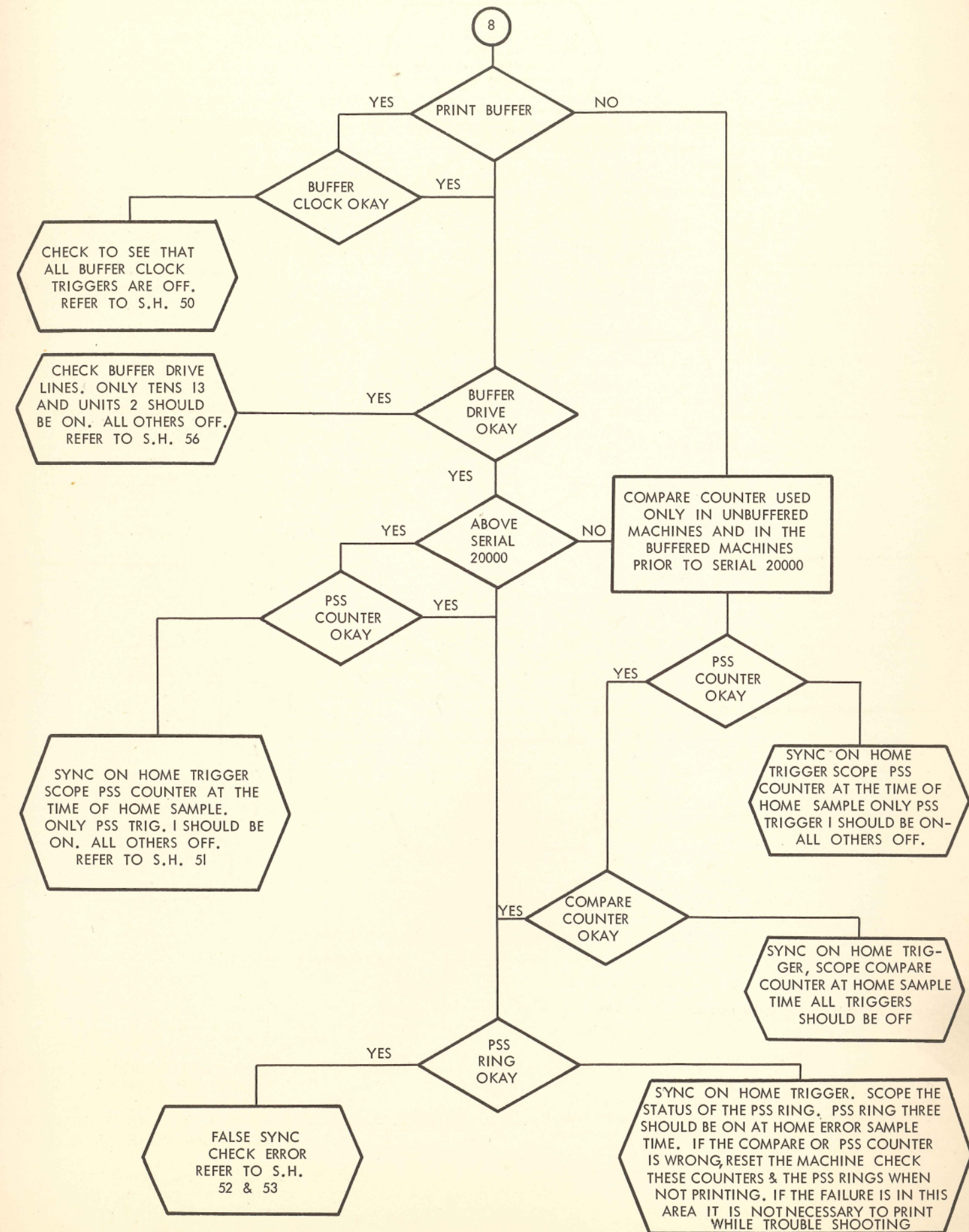

# SYNC CHECK SERVICE HINTS

## S.H. 46 BINDING CHAIN

If chain is suspected of binding and cannot be felt by rotating by hand, remove the chain and cartridge and try printing a few lines. If the chain is extremely dirty and cannot be cleaned with type cleaner, it should be cleaned by the off cartridge method (Refer to I403 Reference Manual for procedure).

## S.H. 47-A. METHOD OF CHECKING DRUM PULSE

Read head to disk clearance should be checked with a piece

of paper, not with the feeler gages (carriage tape is good). The drum pulse should be checked for amplitude (50 to 150 millivolts, peak to peak, one side of read head to ground). Any variation in timing or amplitude is an indication of mechanical wear. PSS pulse should not vary more than 530-580 microseconds between pulses. Check for worn timing disc key or loose drum mounting screw. Worn or broken sprocket teeth will give you sync checks. The lower chain drive motor bearing can cause variations in the P.S.S. pulse. Refer to Print Timing Control Chart.

# PRINTER TIMING CONTROL

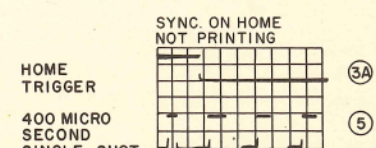
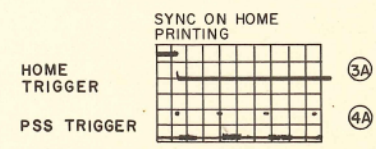
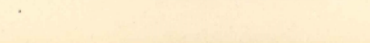
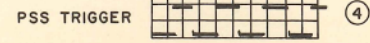
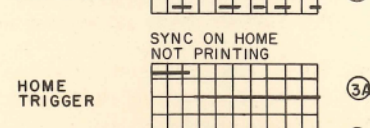
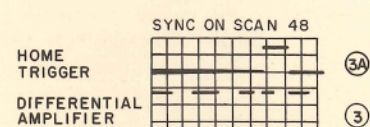
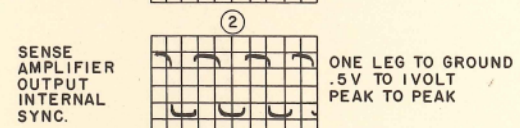
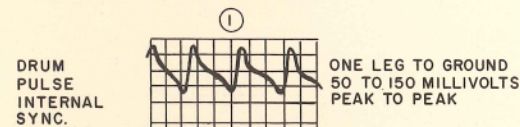
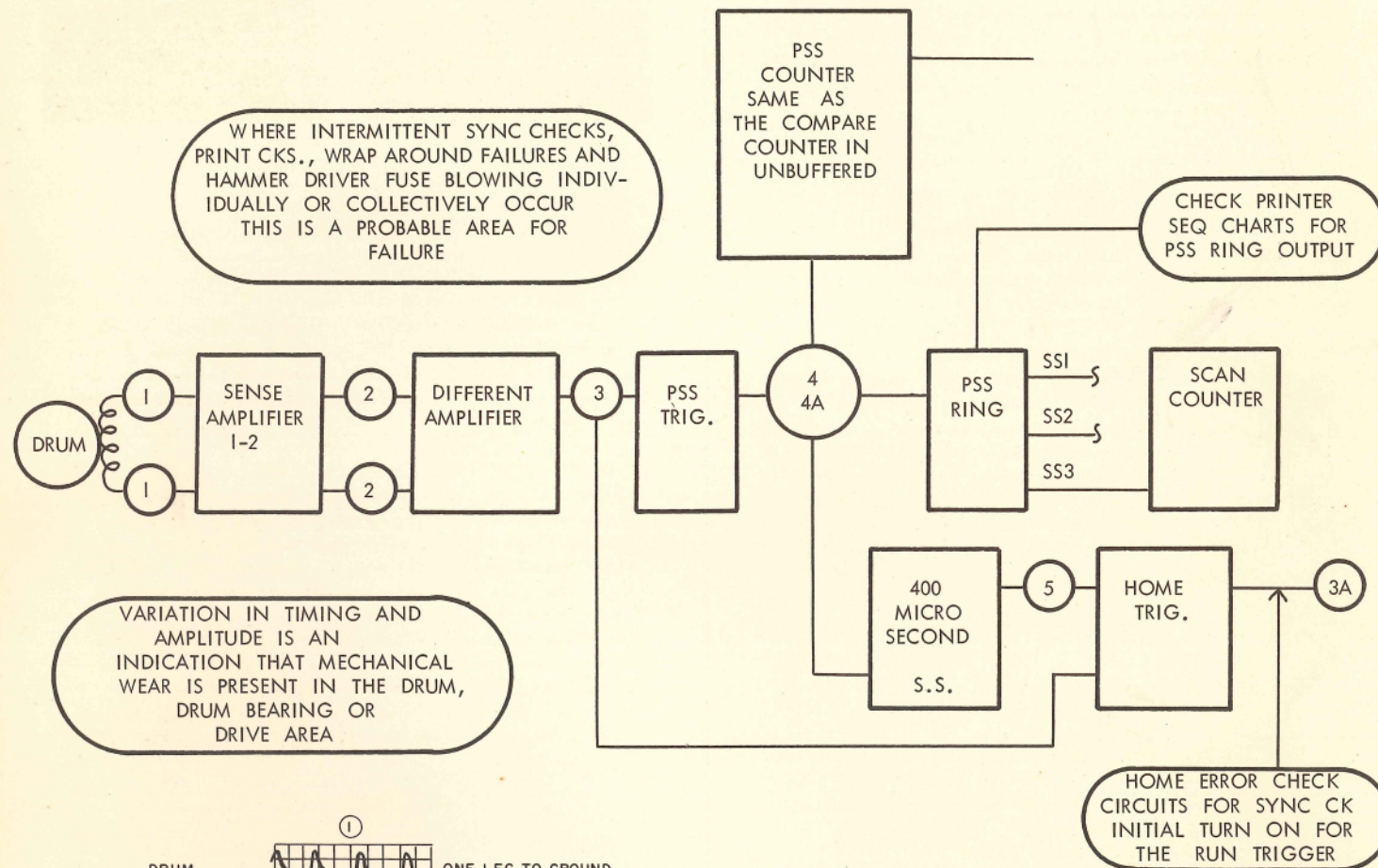

SYNC POINTS AS INDICATED ALL TIME 200MICRO SECOND PER DIVISION  
10-1 ATTENUATOR .5 VOLTS PER DIVISION ON SCOPE FOR ALL ITEMS EXCEPT 1 AND 2

## B. METHOD OF CHECKING I403 TIMING DISK MAGNETISM

The following procedure can be used when magnetizing the I403 timing disk to determine if the timing disk is biased to give the best possible rise time to the PSS pulse at the PSS trigger. Refer to Magnetize Timing Disk, in the IBM I403 CE Reference Manual for the magnetizing procedure. To perform steps 5 or 7, do the following:

1. Use 10 to 1 voltage probe.
2. Trigger scope on external sync plus.
3. Sync on the PSS pulse at pin A of 01A6A23 (36.31.01.2)
4. Set sweep speed to 100 us per division.
5. Probe the PSS pulse and align the rise of the pulse on the center line.

Adjust the horizontal control so the rise of the PSS pulse is on the center line of the scope face as shown in Figure a. The wave shape shown in Figure b, a picture of the magnetic impulses directly from the timing-disk read head. The sharpest change in wave form at the center line gives the best rise time to the PSS pulse at the PSS trigger.

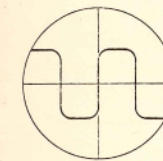

(a) SYNC PULSE

0.5 Volts/Division  
100 sec./Division Sweep  
10 to 1 Voltage Probe

At Disk Speed of 750 RPM

1. 50 - 150 MV from each leg.
2. 100 - 300 MV peak to peak across both legs.
3. 530- 580 sec. between PSS pulses.
4. Rise time .5 sec. maximum. (Measurements taken at output of Differential Amplifier)
5. PSS pulse #144 is 230 - 330 sec. from home pulse.

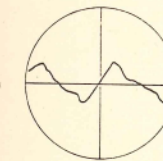

(b) CORRECT BIAS

0.01 Volts/Division  
100 sec./Division Sweep  
10 to 1 Voltage Probe

Sync same as set up in Figure a. Probe I403 SA 1 pin B or D.

Wave shape shown in Figure b is a picture of the magnetic impulses directly from the timing disk read head. The sharpest change in wave form at the center line will give the best rise time to the PSS Pulse at the PSS Trigger.

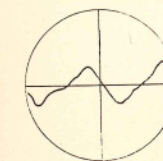

(c) CORRECT BIAS

Same set up as in Figure b Wave shape being the inverse of Figure b means only that the Read Head wires are reversed.

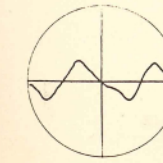

(d) INCORRECT BIAS

Same set up as in Figure b The sharpest change in wave form is not on the center line of the Scope Face.

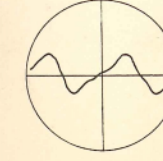

(e) INCORRECT BIAS

Same set up as in Figure b Wave shape being the inverse of Figure d means only that the Read Head wires are reversed.

## S.H. 48 A METHOD OF CHECKING PSS PULSE VARIATION BY SCOPING PRINT READY.

1. Sync on Print Ready going on.
2. Scope Pin N (Print Ready Trigger going off). Refer A.L.D.'s for location.
3. Program 2444 in location 444.
4. Set scope to 10 microseconds per division and 2 volts per division.
5. Start program and observe. Print ready being turned off by the PSS pulse, should not vary more than 50 microseconds.

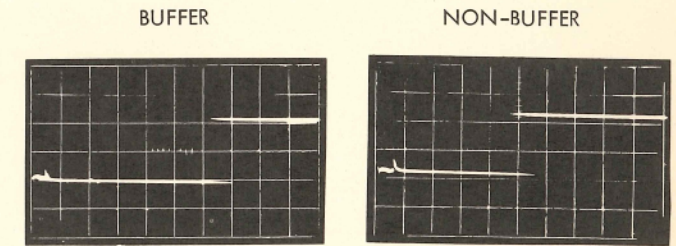

2V per div  
10u sec. per div.  
10-1 voltage probe

On non-buffered machines, this is approximately 15-65 usec. after Print Ready is turned on. On Buffered machines, it is approximately 25-75 usec. after Print Ready is turned on. If excessive variation is observed, the PSS pulse should be scoped. Refer to S.H. 47.

## S.H. 49 CHAIN MOTOR BEVEL GEARS

Intermittent sync checks and/or wrap around errors can occur from worn or misaligned bevel gears in the drive motor gear housing. B/M 485965 provides parts and instructions to replace component parts of the gear housing assembly (I401 CEM 412). IBM Lubricant #22 is now recommended for use in the Chain Drive Motor bevel gear housing. The following procedure is recommended to simplify relubrication of the bevel gear chain unit. The unit must be lubricated at three month intervals with IBM #22 grease.

1. Remove the read head cover over the chain drive gears.
2. Remove the screw from the chain motor gear housing as indicated.

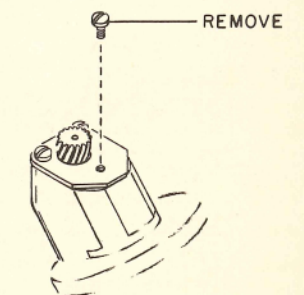

3. Add #22 grease through this tapped hole with a small diameter nozzleed grease gun extension (P/N 450566). Depress the plunger on the grease gun a sufficient number of times to force the grease out of the tapped hole or around the pinion gear.
4. Replace screw and wipe off excess grease from the housing.
5. Run The motor approximately five minutes so that excess grease will be forced out around the pinion gear. Stop the motor and wipe off any excess.
6. Replace the Read Head Cover.



S.H. 50 CHECK BUFFER CLOCK  
Tie pin E of the clock control trigger to ground. This will make the buffer clock triggers run continually. 36.34.11.

BUFFER CLOCK TIMING

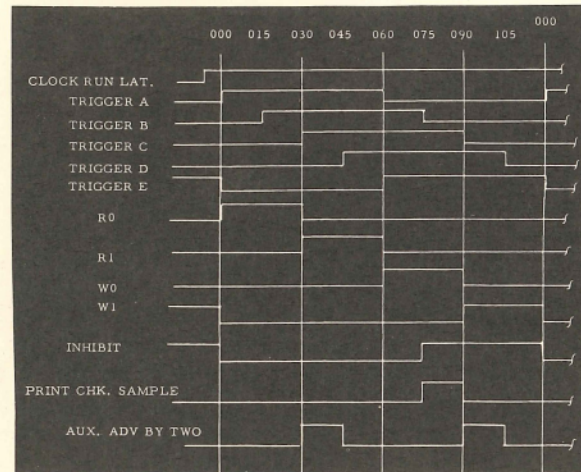

S.H. 51 CHECKING ADVANCE PULSES AND ADJUSTMENT CYCLES OF PSS COUNTER ON PRINT BUFFER MACHINES.  
Wire in the home pulse to allow printing to begin at home time only. Clear the print area to blanks. 2444 at location 444.  
1. Enter a 1 in print position 1 (201) and a C in print position 130(330). Execute a print op. and check that the 1 and D printed O.K. This checks the advance by 2.  
2. Enter a 2 in print position 2 (202) and a D in print position 131 (331). Execute a print op. and check that the 2 and D printed O.K. This checks the +11 correction of the PSS Counter at the end of Sub scan 1. Enter a 3 in print position 3(203) and an E in print position 132(332). Execute a print op. and check that the 3 and E printed O.K. This checks the +11 correction of the PSS Counter at the end of Sub scan 2.  
3. Enter a 4 in print position 4 (204). Execute a print op. and check that the 4 printed O.K. This checks the +9 correction of the PSS Counter at the end of Sub scan 3. If all 7 characters are printing correctly, the PSS Counter is operating properly.  
Refer to the following charts. (A, B, C, D) Without Print Buffer refer to Chart E.

PSS COUNTER

CHART A  
PSS COUNTER ADVANCED BY 1 (NOT PRINTING)

CHARTS ARE FOR SYSTEMS ABOVE SERIAL #20000 WITH PRINT BUFFER

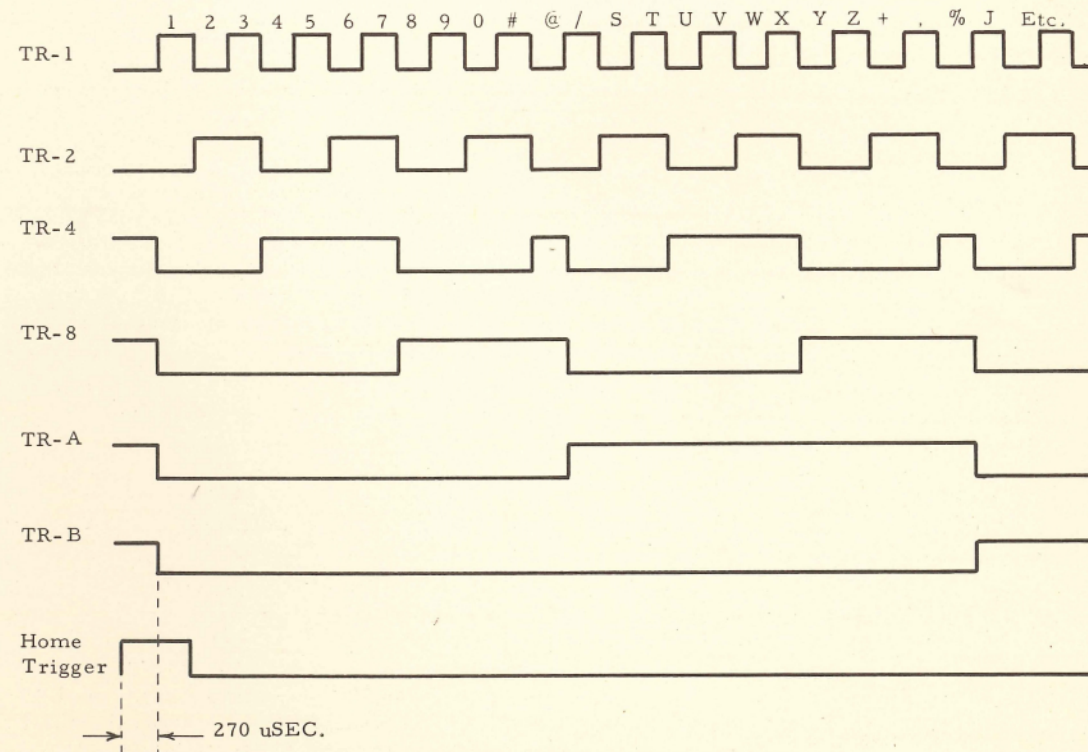

1. DO NOT PRINT: SYNC ON HOME TRIGGER GOING POSITIVE. COUNTER SHOULD ADVANCE BY 1 EVERY THIRD PSS PULSE (PSS PULSE ASSOCIATED WITH A SUB SCAN 1. PATTERN SHOULD BE AS SHOWN EACH DIVISION REPRESENTS 3 SUB-SCANS (1.65 MILLISECONDS).

PSS COUNTER

CHART B  
PSS COUNTER ADVANCED BY 2 (EVEN) SCAN 48

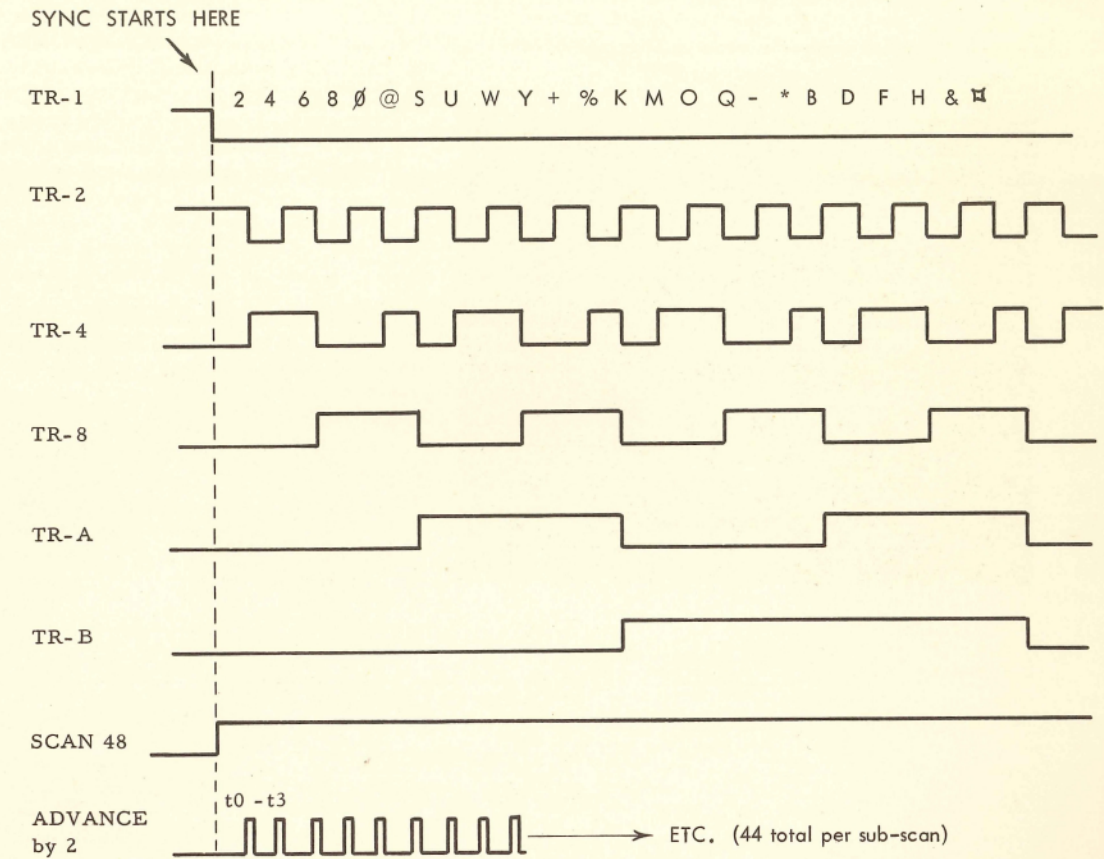

1. JUMPER TO ALLOW PRINTING TO BEGIN ONLY WITH THE PSS PULSE FOLLOWING THE HOME PULSE. SYNC. ON +U SCAN 48 GOING POSITIVE AND PRINT. TRIGGER I SHOULD TURN "OFF" WITH THE FIRST PSS PULSE AND THE PATTERN SHOULD BE AS SHOWN ABOVE. EACH DIVISION IS A CLOCK CYCLE. (11.1 MICROSECONDS)

CHART C  
PSS COUNTER ADVANCED BY 2 (ODD) SCAN 1

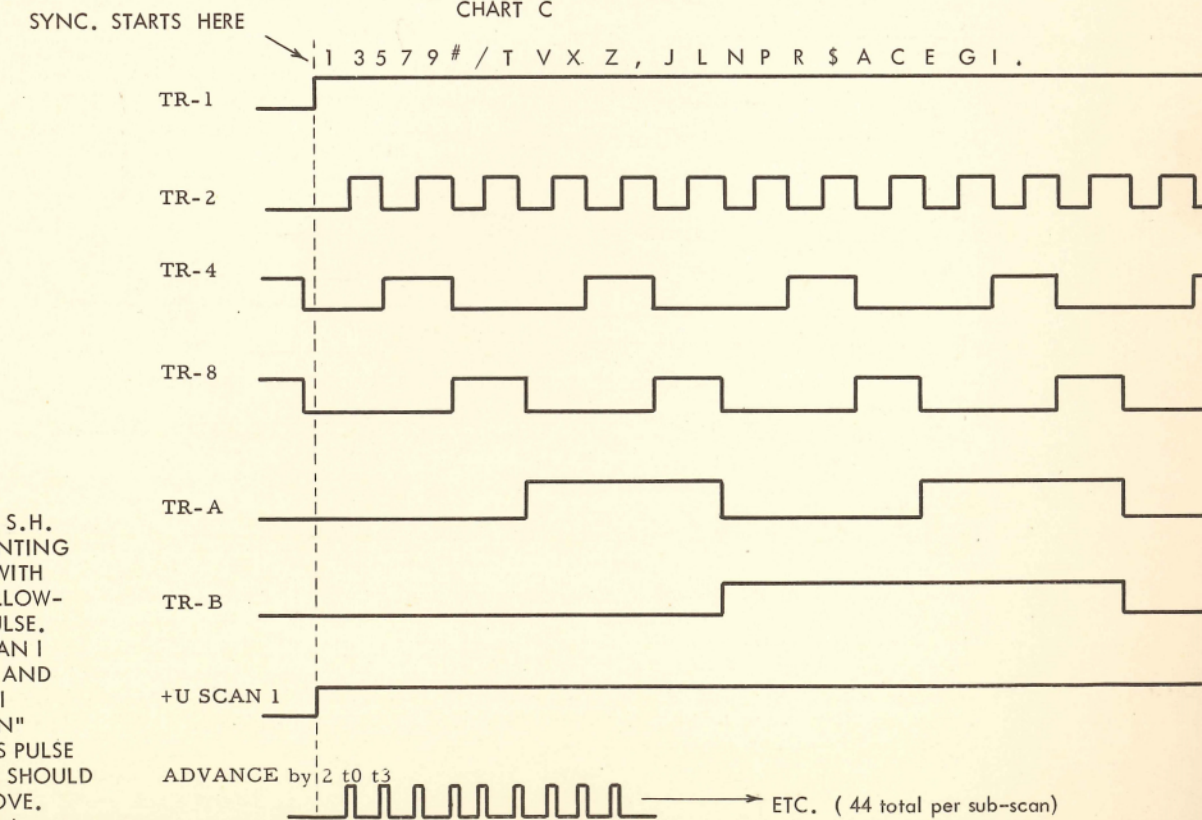

1. JUMPER (REFER TO S.H. 58) TO ALLOW PRINTING TO BEGIN ONLY WITH THE PSS PULSE FOLLOWING THE HOME PULSE. SYNC. ON +U SCAN 1 GOING POSITIVE AND PRINT. TRIGGER I SHOULD TURN "ON" WITH THE FIRST PSS PULSE AND THE PATTERN SHOULD BE AS SHOWN ABOVE. EACH DIVISION IS A CLOCK CYCLE. (11.1 MICROSECONDS)

# PSS COUNTER

CHART D

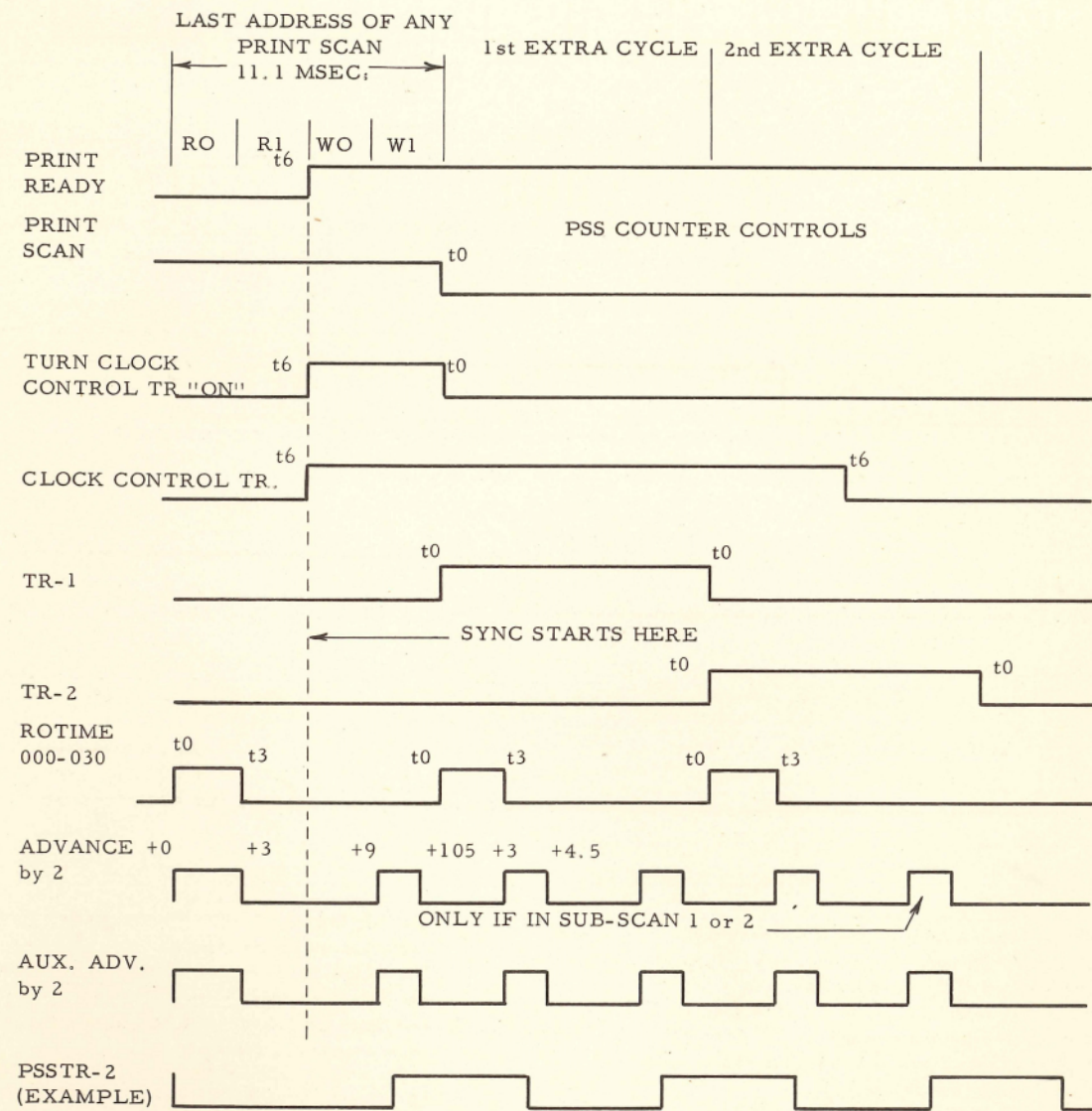

1. SYNC. ON CLOCK CONTROL TRIGGER GOING POSITIVE AND PRINT. PATTERN SHOULD BE AS SHOWN ABOVE.

# PSS COUNTER

CHART E

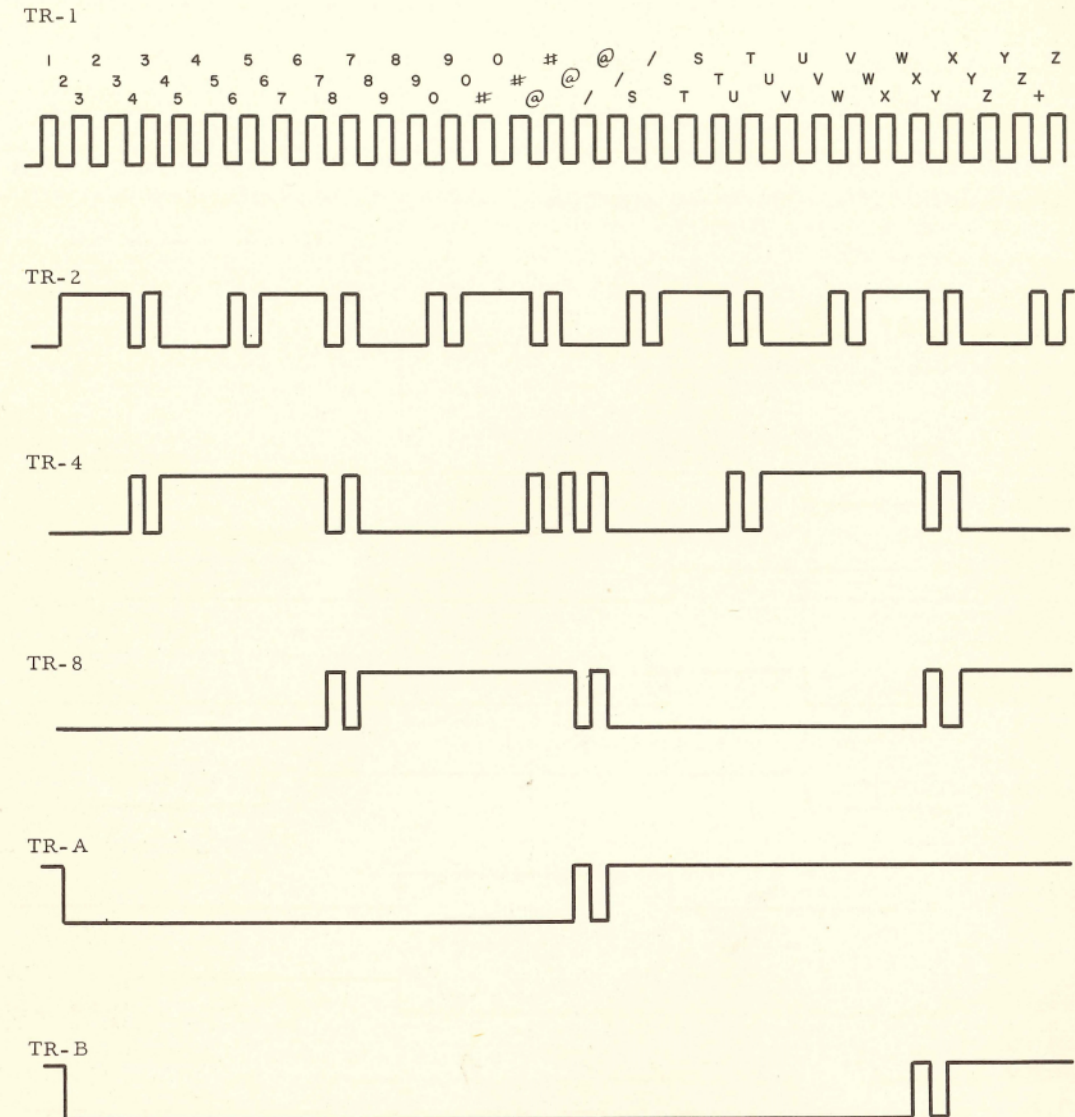

NOTE: TRIGGER B NOT DRAWN IN STEP BECAUSE OF THE DURATION OF THE PULSE. WITHOUT PRINT BUFFER

### S.H. 52 INTERMITTENT FALSE SYNC CHECK ERRORS

1. Scope drum pulses and home trigger circuitry. Refer to "Printer Timing Control Chart" page 36
2. Check drum bias, refer to S.H. 47. See I403 Reference Manual, for drum biasing procedure.
3. A defective 400 usec. single shot pot in the home pulse circuitry will cause sync checks.
4. Sync checks when hitting the stop key on the printer have been traced, in some cases, to noise on a wire from the stop key. This noise, couples to the twisted pair of wires leading to the sense amplifiers, results in improper pulses to the PSS counter. A solution to this has been to switch the stop key wire with a spare wire in the cable.
5. Noise from the gate interlock switch or the ribbon reverse switch will cause intermittent sync checks.
6. The right side cover shorting to SA 1 & 2 pins will cause sync checks.
7. When intermittent sync checks are experienced, put the machine in a print and branch operation. Scope all the CW triggers in gates 01A6. All triggers should come on within 1.5 usec. with overshoot and remain at a down or up level until they are reset.
8. The Print Scan Counter can be checked by wiring a timing pulse to the binary input of Trigger 1. Each trigger

will flip back and forth with the exception of trigger 32 which is not binary coupled. The following BM's are available to correct certain machine problems.

9. Eliminate sync checks and failure to space after print when stop key is depressed.
 

1401	25,000 Series	CEM 480
1401	10,000 Series	CEM 488

### S.H. 53 SYNC CHECKS CAUSED BY NOISE

If sync checks seem to be caused by noise, a GJ--card, Part # 371501 should be installed in the gate in question to reduce noise. The card must be installed in an empty position where the voltage buss is connected. More than one card may be installed in the same gate, if one doesn't reduce the noise sufficiently.

### S.H. 54 THERMAL LIGHTS

Thermal Interlock light indicates either chain motor terminal or hammer unit thermal has operated because of an over temperature condition. When this occurs, Fuse 14 or 15 in I403 blows. Outside temperature of chain motor should be under 140°. A binding lower bearing in the chain drive motor will cause the motor to run hot.

NOTE: Final setting of emitter adjustment arm should be for the least time from the stop impulse until the tractor shaft movement is settled, compromised between triple space six lines per inch and double space eight lines per inch.

D. Adjust carriage tape sprocket as per S.H. 12E. If when checking hydraulic carriage adjustments using the Tach-generator, the expected wave forms are not

as shown in S.H. 12 and 13, investigation should be made further by the C.E. Incorrect waveforms are a definite indication of trouble and these symptoms should not be overlooked. Refer to S.H. 6 for erratic carriage behavior. Refer to Figure 16 for expected scope trace in skip operation.

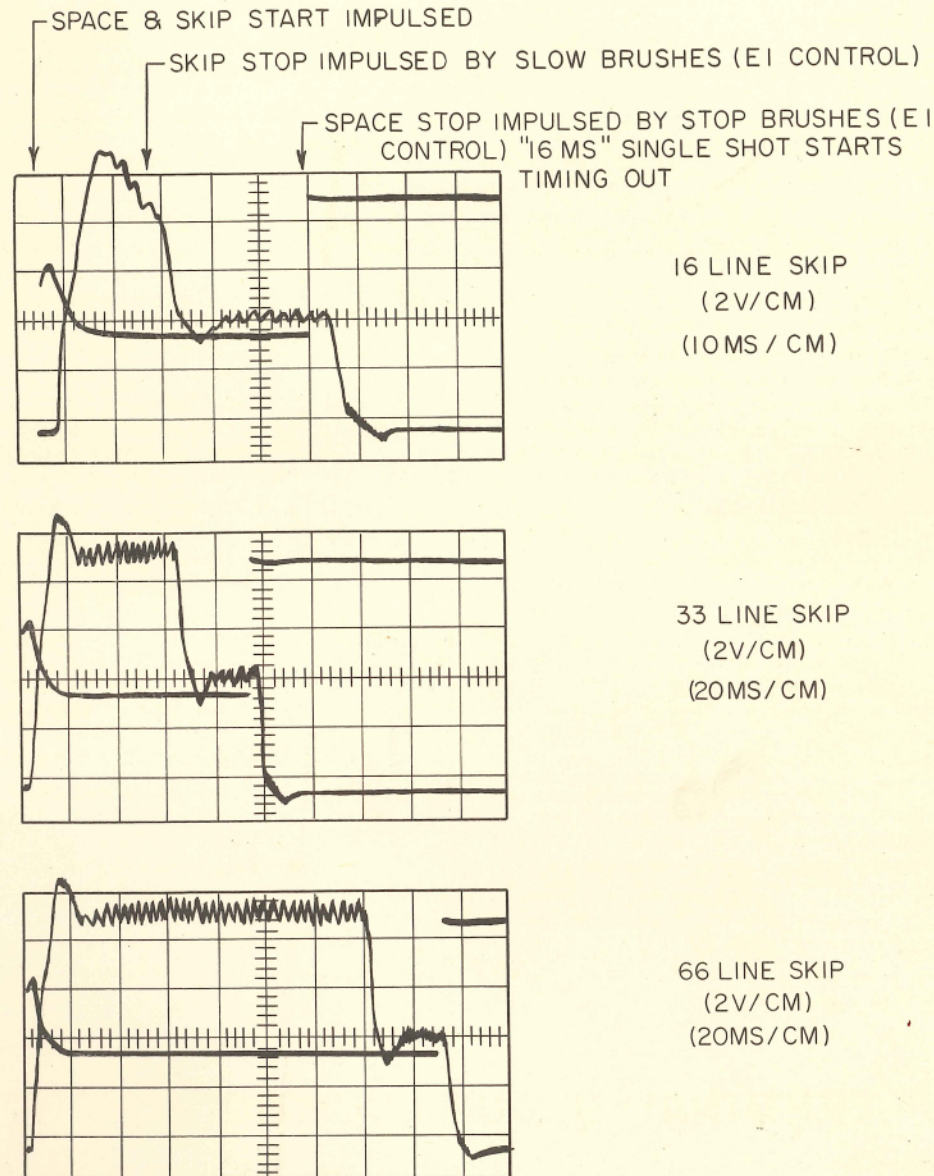

16 LINE SKIP  
(2V/CM)  
(10MS/CM)

33 LINE SKIP  
(2V/CM)  
(20MS/CM)

66 LINE SKIP  
(2V/CM)  
(20MS/CM)

FIG. 16 TACH-GENERATOR TRACES ON SKIPPING OPERATIONS

S.H. 14 SPECIAL SKIP CASES

I. SINGLE LINE SKIP FAILURES:

Check E1, 4.5 m.s. and 10 m.s. single shot timings. Refer to S.H. 12 or 13. The 10 m.s.s.s. should be 1.7 m.s. less than the final setting of the 16 m.s. single shot. The 2005 diagnostic checks single line skip.

The following is a brief description of special skip operations.

II. SINGLE LINE SKIP

A. If a 5 hole is under the channel brush and a skip to 5 instruction occurs, a skip of 1 line will take

place. NOTE: 5 hole is used as an example.

1. Because the channel register does not set up until the carriage is signalled to move, the carriage can start at slow speed.
2. E1 Emitter and carriage interlock on is needed to read into channel register.
3. Skip instruction will turn on carriage interlock and E1 emitter will read 5 into channel register.
4. Comp skip equal will be signalled but carriage has already started.
5. After 4.5 MS, the E2 brush line is activated and turns on Stop S.S.

III. NO LINE SKIP

- A. If a skip is signalled and the carriage is already at that point.
1. Skip 5 and there is already a 5 in the channel, register.
  2. As soon as skip code comes up, the comp skip equal will prevent turning on Start SS.
  3. Also comp skip equal will turn on Stop SS to reset carriage op reg. and space skip reg. on Skip Before Op.
  4. On a Skip After operation the line Gate Sp Sk Reg prevents Comp Skip Equal from firing the Stop SS.
    - a. Sp Sk Gate resets the Channel Reg and this drops Comp. Skip Equal.
    - b. This leaves the Carriage Op Reg latch and the Space Skip latches on so that on scan 48 a skip operation can start.
    - c. This also allows form to form ejection.

S.H. 15 VALVE BODY REMOVAL

Refer to I403 Reference Manual for standard removal procedure. The following is a quick method of removing the valve body assembly, to replace broken valve stems or making valve stem adjustments. This method is a time saver and is recommended when working on the hydraulic unit, part # 444325. This style has the reservoir holding screws on the inside of the I403. This method is also feasible with hydraulic reservoir, part # 475102. It saves replacing the gasket. Estimated time for removing the valve block assembly is 25 minutes. Special tool needed is a 3/16" allen head tip to be used with the ratchet screwdriver handle.

1. Drain oil out of the hydraulic unit.
  - a. Remove reservoir top cover.
  - b. Remove leads to magnet coil.
3. Remove the two top screws that hold the exhaust baffle. Gently pivot the baffle to attain access to the valve block holding screws.
4. Use ratchet screwdriver handle with 3/16" allen head tip. Remove the two bottom screws and then the two top screws. The block is now free to be removed from the hydraulic unit. A standard 3/16" allen wrench can be used to loosen the screws, if the screws are found too tight to start. CAUTION: Extreme care should be exercised when working on the reservoir unit. The access hole may have sharp edges.

S.H. 16 SPECIAL TOOL

The following is a method to make a 3/16" allen head tip to fit the ratchet screwdriver handle when the special tip is not available.

Grind down a 1" piece of a 1/4" allen wrench to fit a 3/16" allen head. The shank should be 1/4" so that it will fit the ratchet screwdriver handle. This special tip will be used to remove the four valve block holding screws.

S.H. 17 FORM CONTROL DIAGNOSTICS

Run carriage diagnostics. This usually is a fast method in determining exact type of carriage failure you are experiencing.

The following is a list of the 2,000 series Forms Control Diagnostics.

- A. 2000 FORM SPACING
    1. Test all types of spacing singly and in combination.
  - B. 2005A SINGLE LINE SKIP TEST
    1. Test single line skip operation to all channels.
    2. Test the interlocking of the branch on 9 or 12.
- NOTE: Run 2020C diagnostic before 2005 diagnostic.
- C. 2,010 FORMS SKIPPING (high and low speed)
    - 1) Tests skips to all channels using 6, 14, and 22 spaces.
    - 2) Tests no line skip.
    - 3) Tests single item eject.
  - D. 2012 HIGH SPEED SKIP AND SINGLE ITEM EJECT
    - 1) The carriage skips at high speed to a given channel (all channels are tested).
    - 2) The carriage does not skip when it is sitting at the channel called for and a skip before print is given (all channels are tested).
    - 3) The carriage does skip when it is sitting at a channel called for and a skip after print is given. (A skip to 2 is used to check this circuitry).
  - E. 2020C CHANNEL 9 AND 12 LATCH TEST
  - F. 2030C CHECK SPACE SUPPRESSION

S.H. 18 PROCEDURE TO SCOPE SLOW BRUSHES

- A. Punch a tape using all channels.
- B. Clear print area to C bits. Program F B bit 2 444 location 444.
- C. Remove carriage block cover to scope brushes.
- D. See I403 reference manual for "Static Adjustment of Carriage Tape Brushes."
- E. Check to see that corresponding latches turn on with make of slow brush and off with the make of the stop brush.

TERMINAL BLOCK LOCATION CHART

TB NO	NO/TER.	W.D. LOC.	DESCRIPTION	PHYSICAL LOCATION	TB NO	NO/TER.	W.D. LOC.	DESCRIPTION	PHYSICAL LOCATION
1	10	01.05.1	DC Input Voltages	Machine Pan- Rear Near Fuse Panel	7	6	01.09.1	Chain Motor	Left end of "T" casting -inside
2	8	02.01.1	Carriage Magnets	Under Hydraulic Reservoir Cover	8	2	01.07.1	Chain Motor Thermal	Left end of "T" casting -inside
3	4	01.07.1	Forms Switches & Hammer Unit Thermal	On left side frame- Inside at top	9	4	01.09.1	Hydraulic Unit Blower (50 cy. only)	On manifold assembly left side of machine
4	4	01.09.1	Hammer Unit Blower	On Motor Frame, upper right rear of machine	10	5	01.07.1	Upper Forms Switches	On translator frame-behind upper tractors
5	2	01.09.1	Ribbon Motor	Right side of ribbon drive assembly	11	5	01.07.1	Lower Forms Switches	On translator frame-behind lower tractors
6	4	01.08.1	Ribbon Clutch Coils	Right side of ribbon drive assembly					

### S.H. 19 CARRIAGE CONTROLS - (SCOPING)

A. Depressing the carriage space key enables scoping of the following:

Sync internal to see output of the single shots.

Refer to the figure below.

1. 80 us. start single shot.
2. 4.5 m.s. single shot. The timing of this single shot is variable (4-9 m.s.) The sum of the 16 m.s. and the 4.5 m.s. single shots should not exceed 21.4 m.s. for 600 line per minute printing.
3. 10 m.s. carriage interlock single shot timing should be 1.7 m.s. less than the final setting of the 16 m.s. single shot.
4. 10 us. stop single shot.

B. Depressing the restore key enables checking of the following:

Refer to Restore Key Chart, Page 26.

1. Channel Register reset (10 us.) 36.43.21
2. Channel Register 9 and 12 reset (10 us.) 36.43.21

C. Depressing the carriage stop key enables the checking of the 9 m.s. single shot.

#### SPACE KEY OPERATION

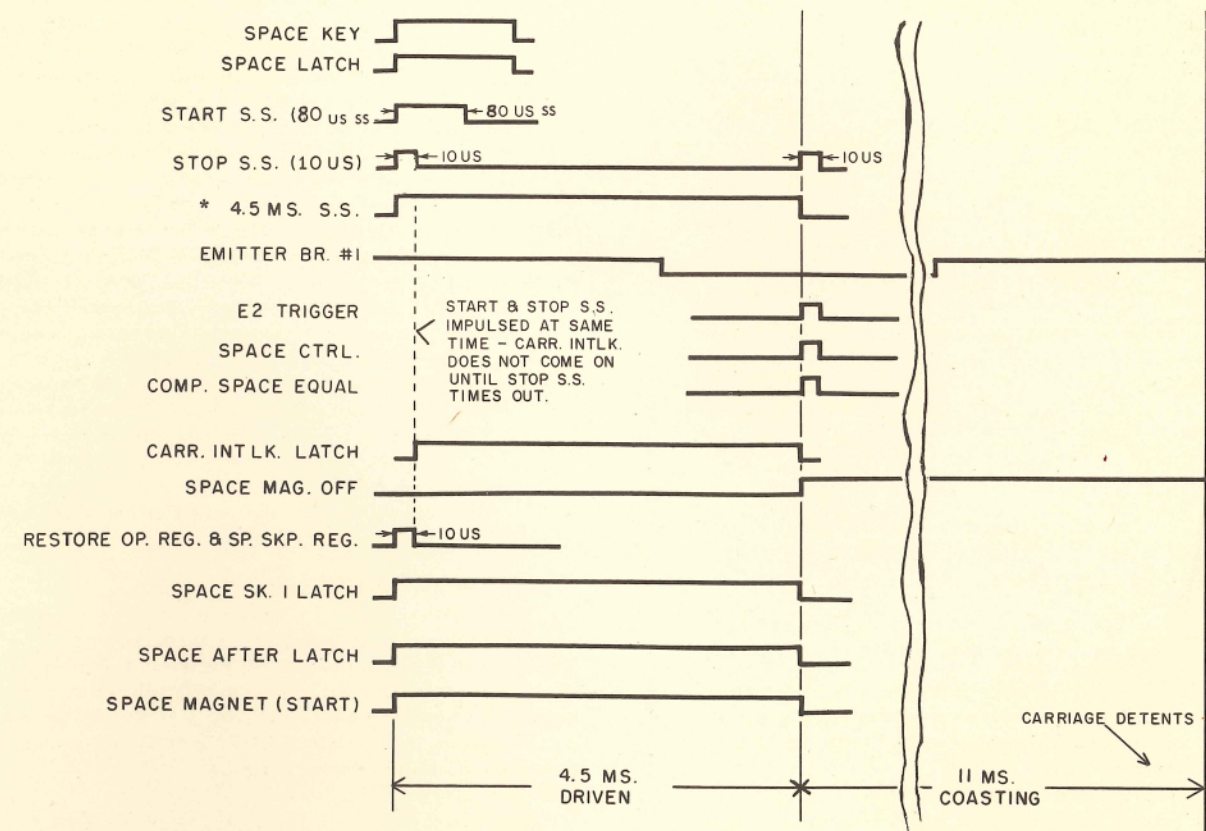

\* TIMINGS MAY NOT BE 4.5 M.S. REFER TO S.H. 12 and 13 FOR ADJUSTMENT PROCEDURES

### S.H. 20 MAGNETIC EMITTER ADJUSTMENT

The following procedure is provided to assist in adjustment and trouble analysis:

#### I. EMITTER WHEEL LOCATION

- a. The emitter wheel should be located .010" to .020" from the nylon bushing as shown in figure 1.

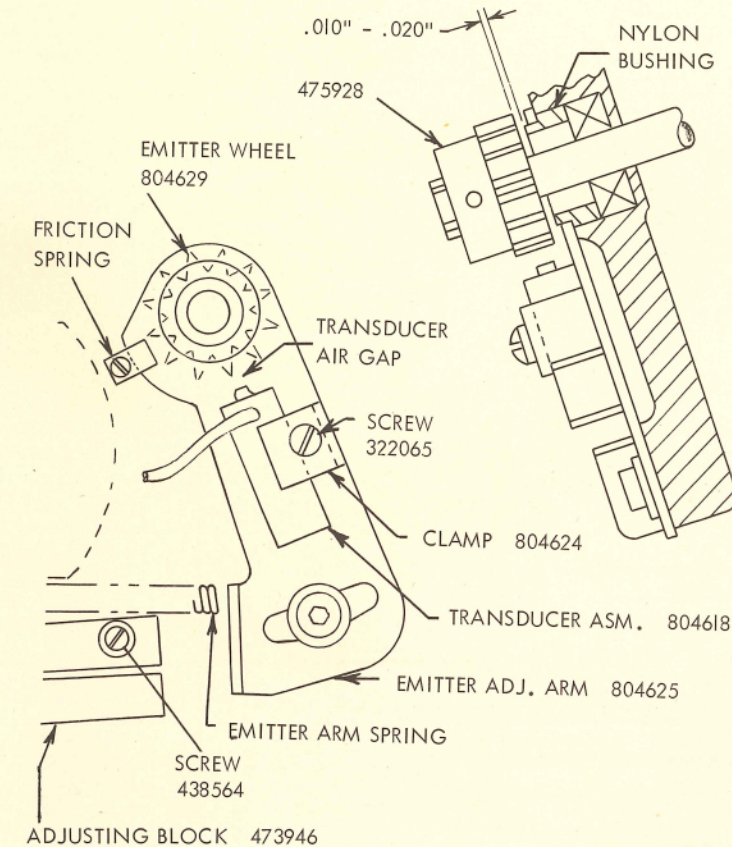

FIGURE 1.

#### II. TRANSUCER AIR GAP ADJUSTMENT

- a. Loosen transducer clamp screw and adjust transducer for .008" clearance to the Emitter wheel. Refer to figure 1.

NOTE: This adjustment may be varied to a minimum of .002" to meet the specified transducer output of 2 to 4.5 volts peak to peak. For example: An increase in air gap will reduce the amplitude of the transducer output and the duration of the EI pulse.

#### III. EMITTER OUTPUT

- a. Disconnect black and white leads from transducer to terminal 8 and 9 of amplifier card. Connect the white lead from transducer to the scope probe, and connect the black lead to the scope ground. With the Emitter wheel operating continuously at low speed, the wave form must appear as shown in figure 2, with an output of 2 to 4.5 volts peak to peak.

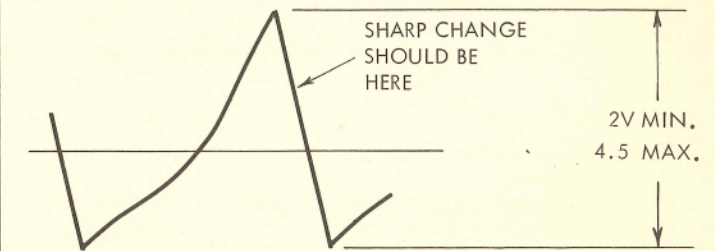

FIGURE 2.

NOTE: To operate continuously at low speed place an IBM card under stop brushes and depress Restore Key.

- b. Reconnect the white lead to terminal 8 and black lead to terminal 9. If the wave has a rapid rise to the positive pulse and a slow drop to the negative pulse, reverse the leads when reconnected to the terminal block to obtain the correct wave form.
- c. With all leads connected and the Emitter wheel operating continuously at low speed, check the amplified output at EI sync point or terminal 1 on the amplifier card for the following:
  1. -8 volts minimum (normally -12 volts).
  2. 1.1 to 1.5 milli-seconds duration.
  3. 2 to 30 micro-seconds rise time.
  4. 1 to 30 micro-seconds fall time.
- d. Timing of the Emitter with the tachometer generator is recommended. See S.H. 12D & 13C.

NOTE: Timing of the Magnetic Emitter is altered by adjusting the Emitter adjusting arm (P/N 804625) in the same manner as for the brush type Emitter. (See figure 1). Timing should be adjusted to obtain the least time to settle tractor shaft movement, compromise between triple space, six lines per inch, and double space, eight lines per inch.

- e. Adjust the carriage tape sprocket so the tape brushes make 1.5+ .25 -0 milli-seconds before the Emitter pulse. The adjusting procedure is the same as with the brush Emitter. Refer to S.H. 12E.

NOTE: All 12 channel stop brushes must meet the above timing relationship to EI Magnetic Emitter.

#### S.H. 21 BROKEN VALVE STEM

The 1st indication of a broken valve stem is continuous spacing with the machine not in operation or program running. If a broken valve stem is suspected, the top cover of the hydraulic unit should not be removed unless the hydraulic drive motor is turned off and valve stems checked. A broken valve stem can cause hydraulic fluid to spurt out the top of the valve assembly. Refer to S.H. 15 for removal procedure.

#### S.H. 22 VALVE STEM LOCK NUTS

The lock nuts on the top of the valve stem can be checked without removing the valve block assembly. The valve block assembly must be removed to check the lower valve stem lock nuts. Refer to S.H. 15 for removal.

## SPACE KEY

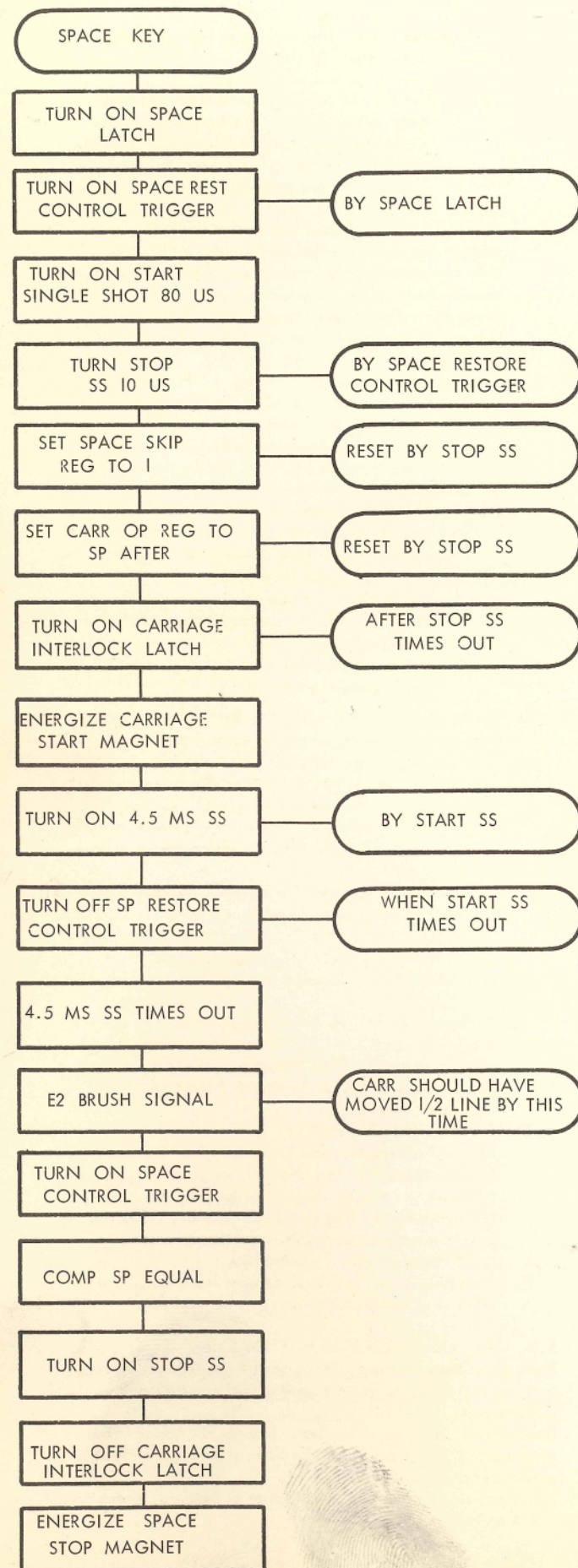

## RESTORE KEY

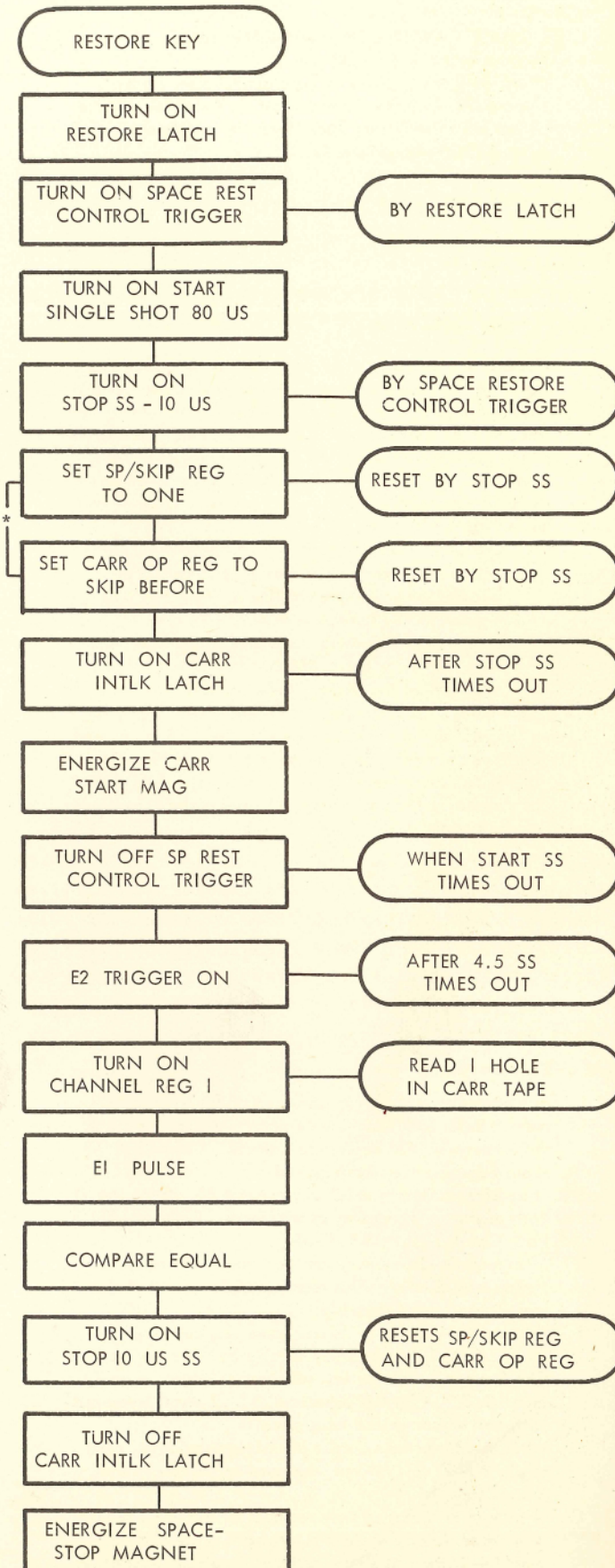

\* TURN ON BY SP REST CNTL LATCH

## PRINT QUALITY SERVICE HINTS

### S.H. 23 DENSITY VARIATION (LIGHT PRINTING)

This can appear in many different ways:

- A. When irregular sections or spots appear more dense (Figure 17), look for excessive oil in the ribbon. Wipe off all excess oil, ink, etc. from the carriage, T-casting, and ribbon shield.

46789012345- 46789012345- -54321098764 -54321098764

9202-2123456789-2029282726252423222010

12223242526272829202-23456789-20292827262524232221010

FIG. 17 Density Variation (Irregular)

Observe the quantity of oil imparted to the ribbon from the chain-lubrication system. A nominal amount of oil does not greatly affect the print quality. Excessive amounts, however, cause a definite problem because of the growth in stroke width and fuzzy edges of the printed characters. If excessive oil is present in the ribbon or around the print area in general, observe the following:

1. Use care when filling the chain reservoir or when oiling the ribbon-drive motor. Oil can drip because of a pressure buildup in the motor (see figure 1, 1403 Reference Manual)
  2. If the chain throws an excessive amount of oil, form the wiper (P/N 474083) so that it just touches the back of the chain. Refer to S.H. 45.
- B. Sometimes when changing from short-line printing to a longer line, the characters at the beginning and end portions of the line of print are more dense than those at the center of the document (Figure 18). This can be caused by the unused (more heavily inked) portions of the ribbon.

12223242526272829202-23456789-202928272625242322217184

12223242526272829202-23456789-202928272625242322217184

12223242526272829202-23456789-202928272625242322217184

12223242526272829202-23456789-202928272625242322217184

12223242526272829202-23456789-202928272625242322217184

12223242526272829202-23456789-202928272625242322217184

12223242526272829202-23456789-202928272625242322217184

12223242526272829202-23456789-202928272625242322217184

FIG. 18 Density Variation

- C. The ribbon shield may be damaged or out of adjustment. Refer to Ribbon Shield and Print-Line Indicator Adjustment in 1403 Reference Manual. Check for sharp edges on the ribbon shield.
- D. If density variations exist in groups of 22, check the corresponding impression-control pads. Refer to 1403 Parts Catalog Fig. 23 Ref. 65.
- E. Worn magnet-armature pivots can cause difficulty in timing and density. This requires replacement of the magnet-and yoke assembly.
- F. The hammer-magnet coils can come unglued from the yoke. This can cause light density and late timing. Check magnet coil for low resistance. (Alpha-numeric 8.3 ± .4 ohms)(Numeric 4.0 ± .2 ohms) measured with coil disconnected from circuits. When measured from output pin of hammer driver card to pin P (-60 volt return) the reading will be 11 and 6 ohms (app.)
- G. A broken or damaged strip residual or fastening band can cause density variation. A worn residual on a machine without the strip residual requires installation of field B/M 485145 or B/M 485348.
- H. When replacing an armature on a machine that has strip residuals, beware of old-style armatures with the individual residual.

- I. Loose platen bond. This can cause light printing at either or both ends. To check:
  1. Remove the chain cartridge.
  2. Remove the cartridge bottom guide plate.
  3. Press on the platen. If oil oozes from between the platen and its bond, replace the cartridge. (When pinned cartridge are used, replace only the cartridge center-bar assembly).
- J. Check for sticky oil and dirt on the hammer rebound damper bar and the armature tail where they meet. This can cause highly intermittent late timing or light density the first time a hammer is used after a period of no use. The damper bar is easily removed from the rear of the machine for cleaning. Refer to 1403 Parts Catalog Fig. Ref. A4.
- K. Improper chain tension.
  1. Hold the cartridge with the printing side up.
  2. Move the chain about two passes in the normal running direction to be sure that the chain assumes a natural sag from the center plate.
  3. The slugs in the center of the cartridge should hang out 1/16" + .020" - .000" to assure proper chain tension (see Figure 5 1403 Reference Manual).
  4. Adjust the cartridge on current machines by loosening the jam nut and turning the idler adjusting screw. Refer to Lower Plate to Cartridge Assembly. 1403 Reference Manual.
- L. Check for proper setting of the density lever and the timing dial. Check for proper forms insertion.
- M.
  1. A fading across the print line indicates that the hammer-unit is not parallel to the chain cartridge.
  2. T-Casting latch (1403 Fig. 15 Ref. A2 Part # 474062) gradually cracking and gradual yielding can cause the loss .083 dimension between hammer and type faces. The latch should be inspected to determine if it is bent or cracked and replaced. Refer to CEM 573. Refer to Horizontal T-Casting Positioning (Chain to Hammer). 1403 Reference Manual.
- N. HAMMER SPLAY (change in clearance from hammer to hammer).
 

Replace the individual hammer assemblies to correct a splayed condition. Do this before timing and density adjustments. (See Adjusting Individual Hammer-Magnet Assemblies for Timing and Density). 1403 Reference Manual.
- O. ERRATIC-PRINT DENSITY
 

On difficult-to-analyze erratic-print-timing problems, inspect for worn chain-drive gears (excessive backlash) or a worn chaindrive sprocket or drive key. If certain hammers or groups of hammers exhibit timing problems only on certain characters; inspect for a damaged or defective timing disk.
- P. Bent nose cone can cause density variation. The nose cone is of soft material and can be straightened.

### S.H. 24 LIGHT TOPS OR BOTTOMS

If all characters that are printed have light tops or bottoms, look for tilting of the hammer unit while you tighten the locking bolts. Check the hammer mounting bar. Inspect the surface that seats against the hammer unit for burrs or foreign matter that would prevent proper seating. If one position is printing light tops or or bottoms, check for a broken hammer.



# PRINT CHECKS

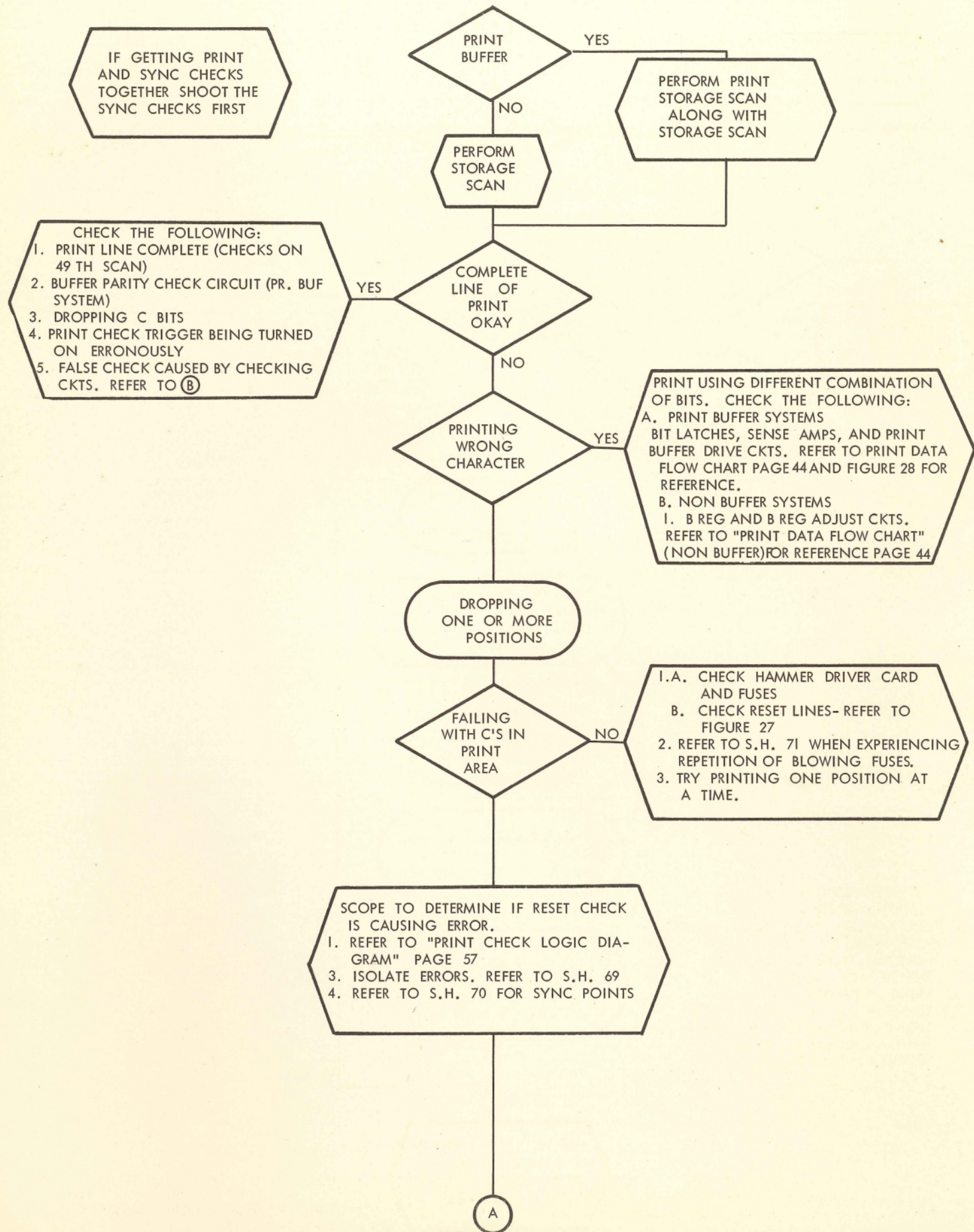

# PRINT CHECKS

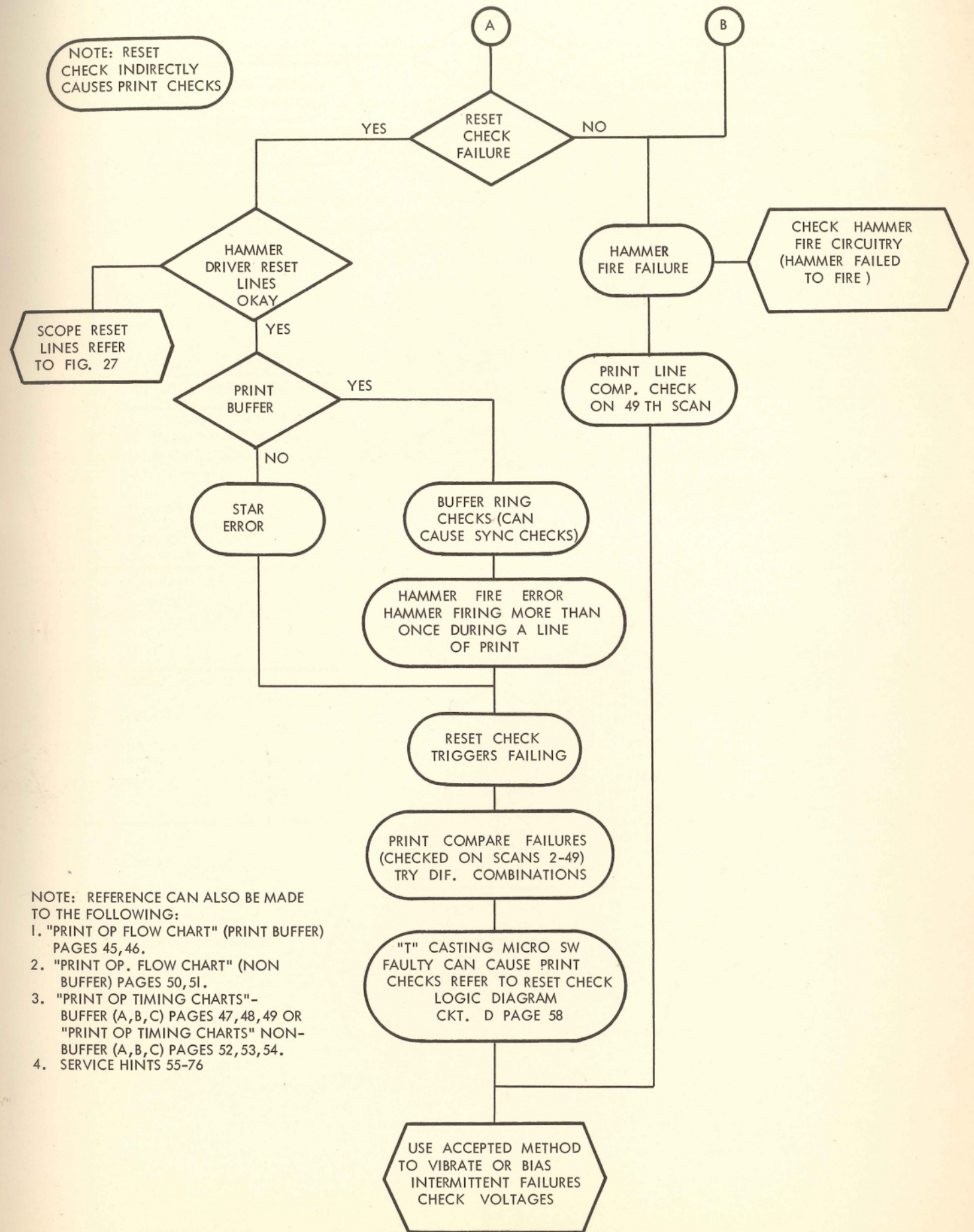

# PRINT DATA FLOW

## BUFFER

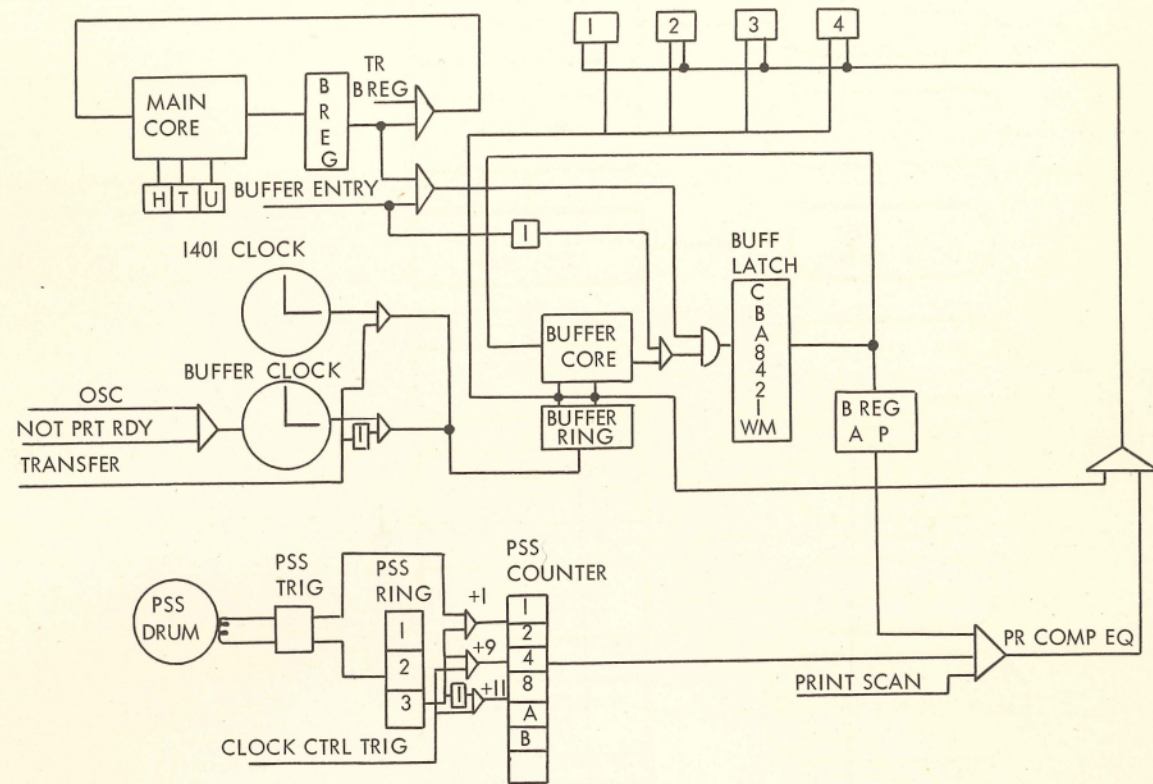

## NON-BUFFER

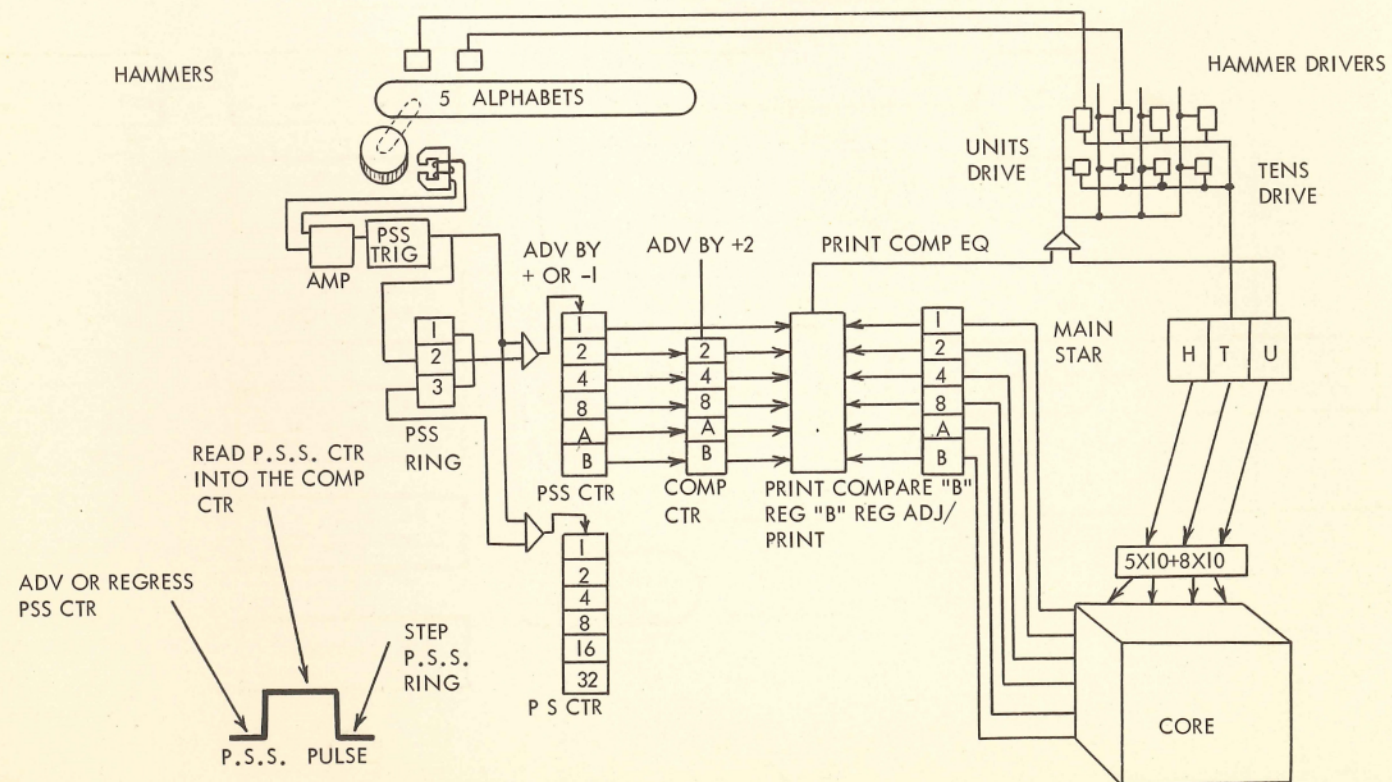

# PRINT OP — BUFFER

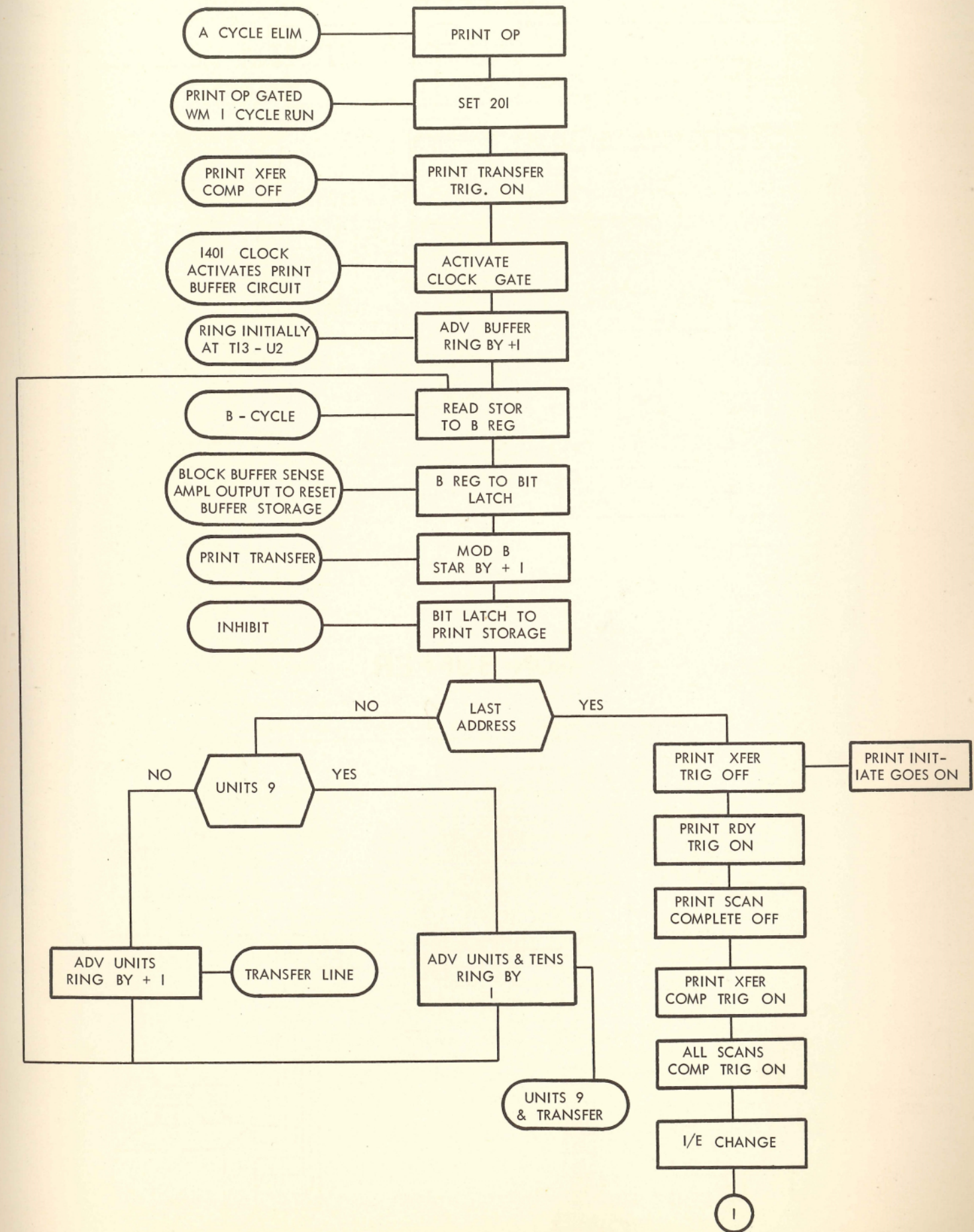



# PRINT OP — BUFFER

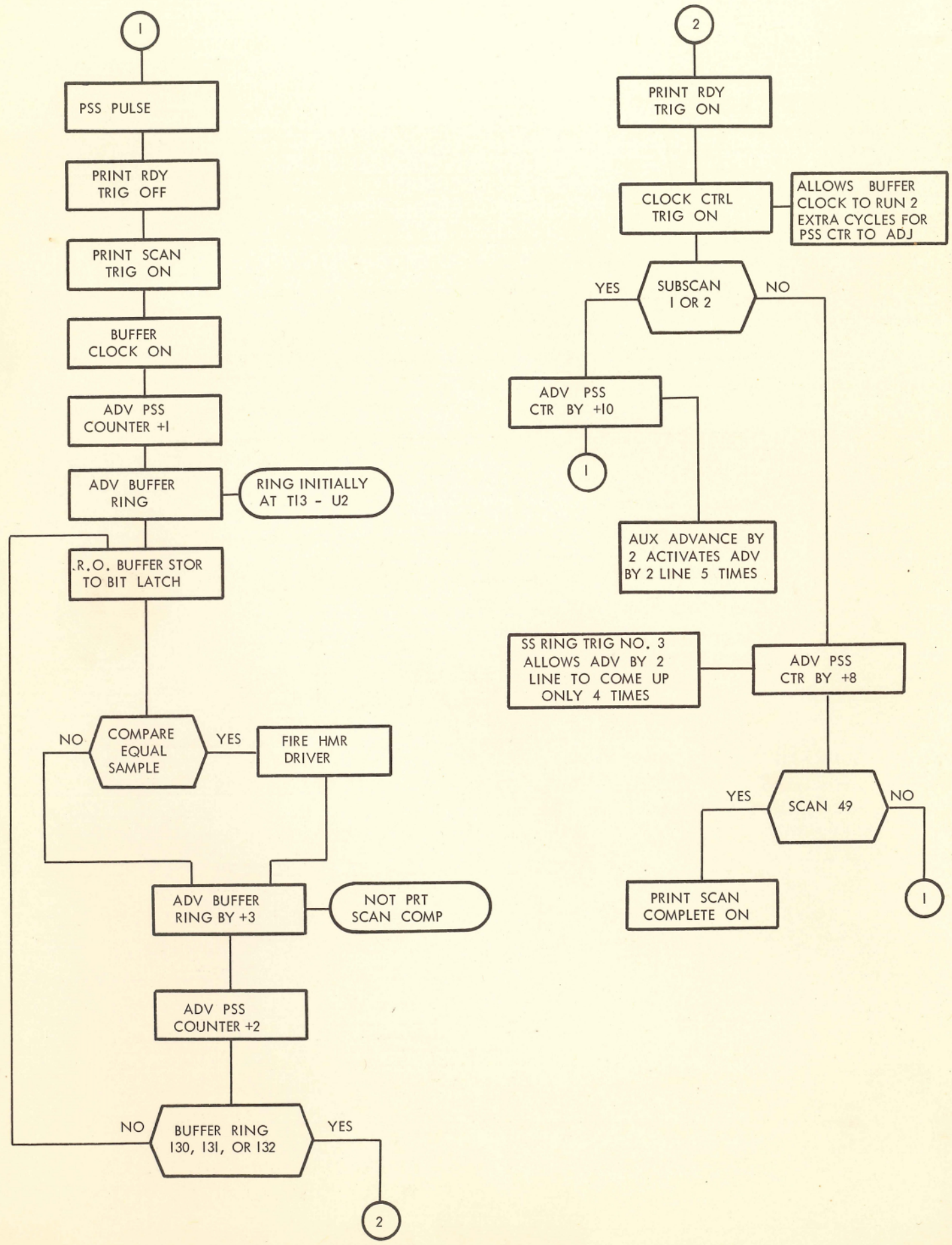

# PRINT OP TIMING — BUFFER

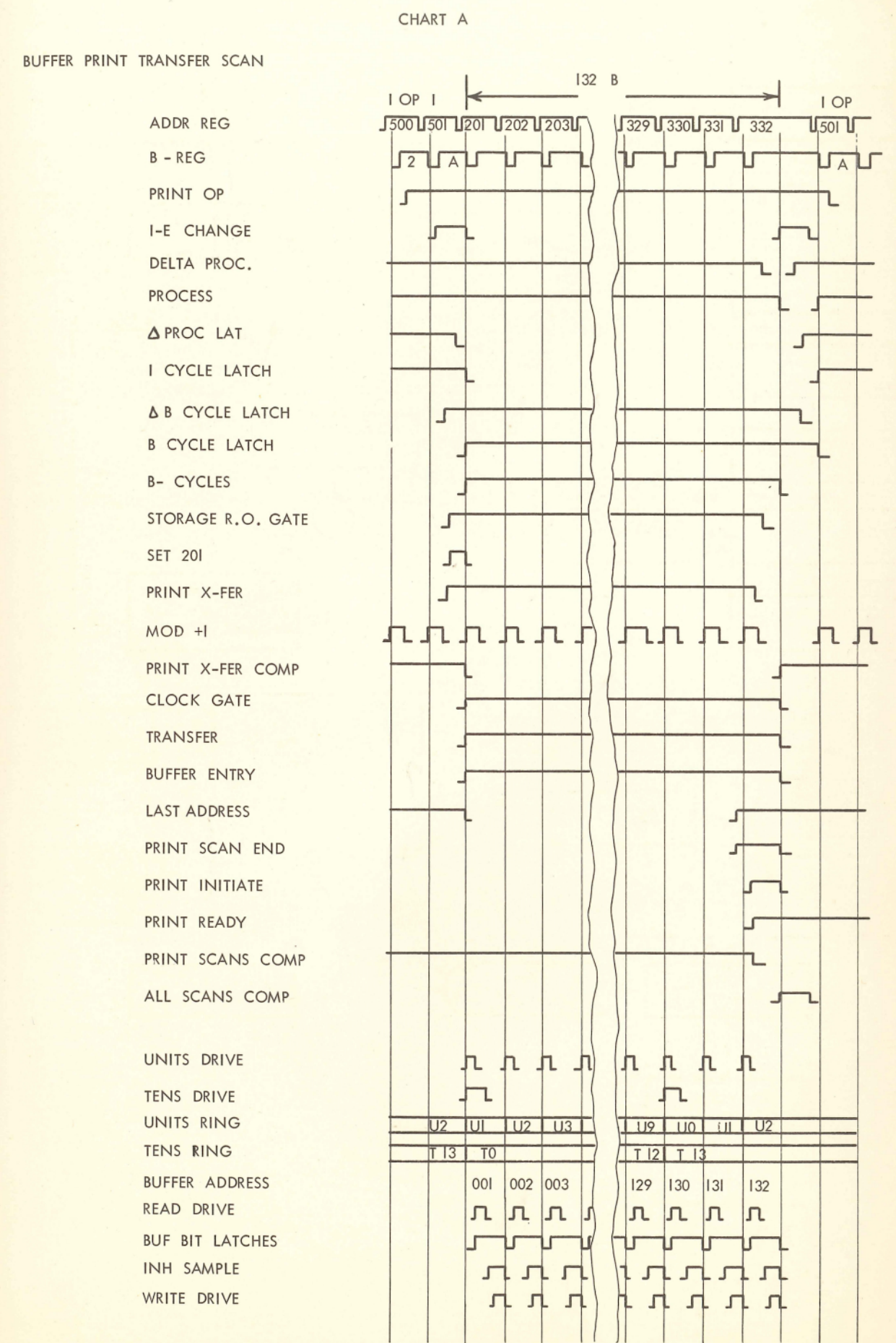

# PRINT OP TIMING - BUFFER

CHART B

PRINT BUFFER PRINT SCAN 1

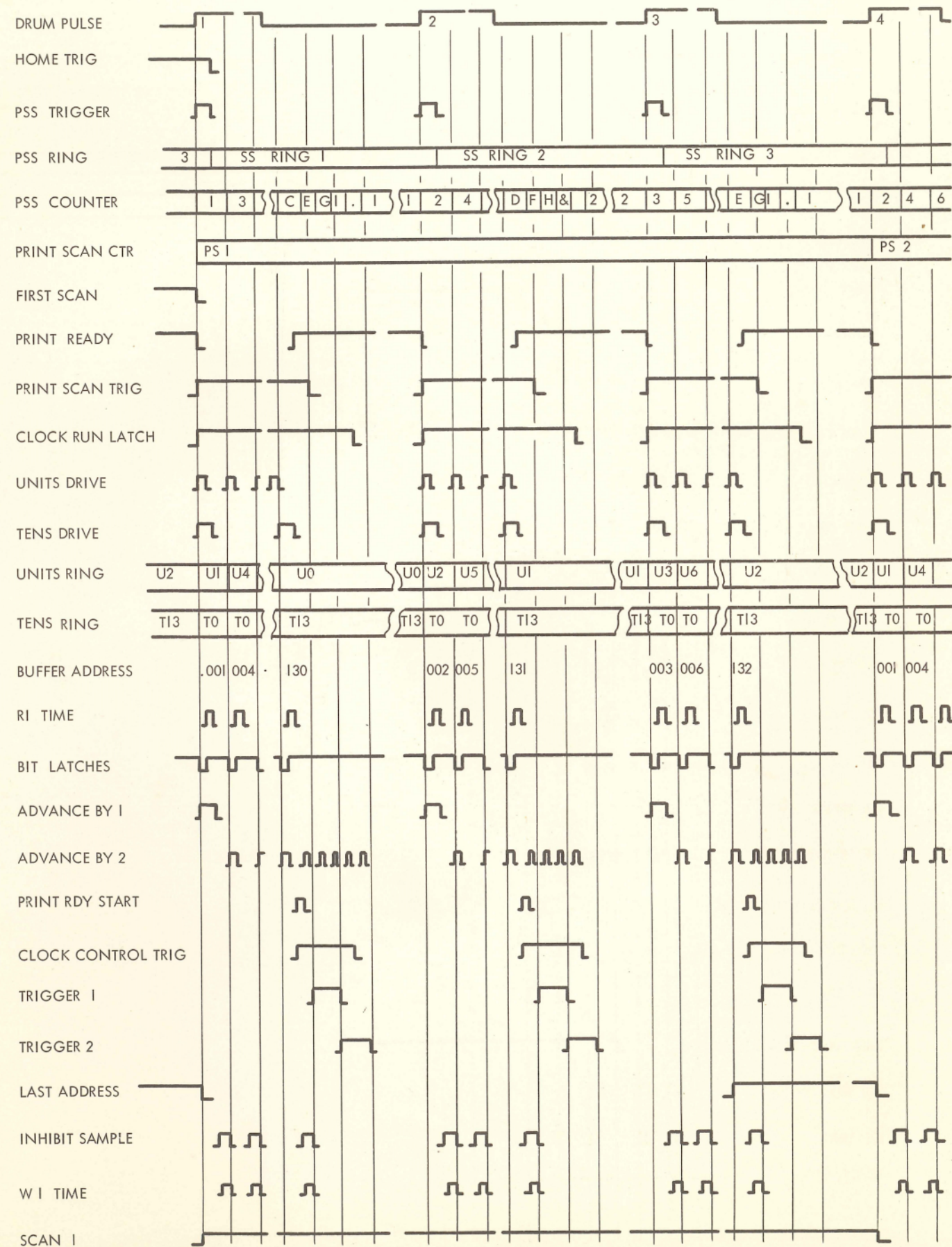

# PRINT OP TIMING - BUFFER

CHART C

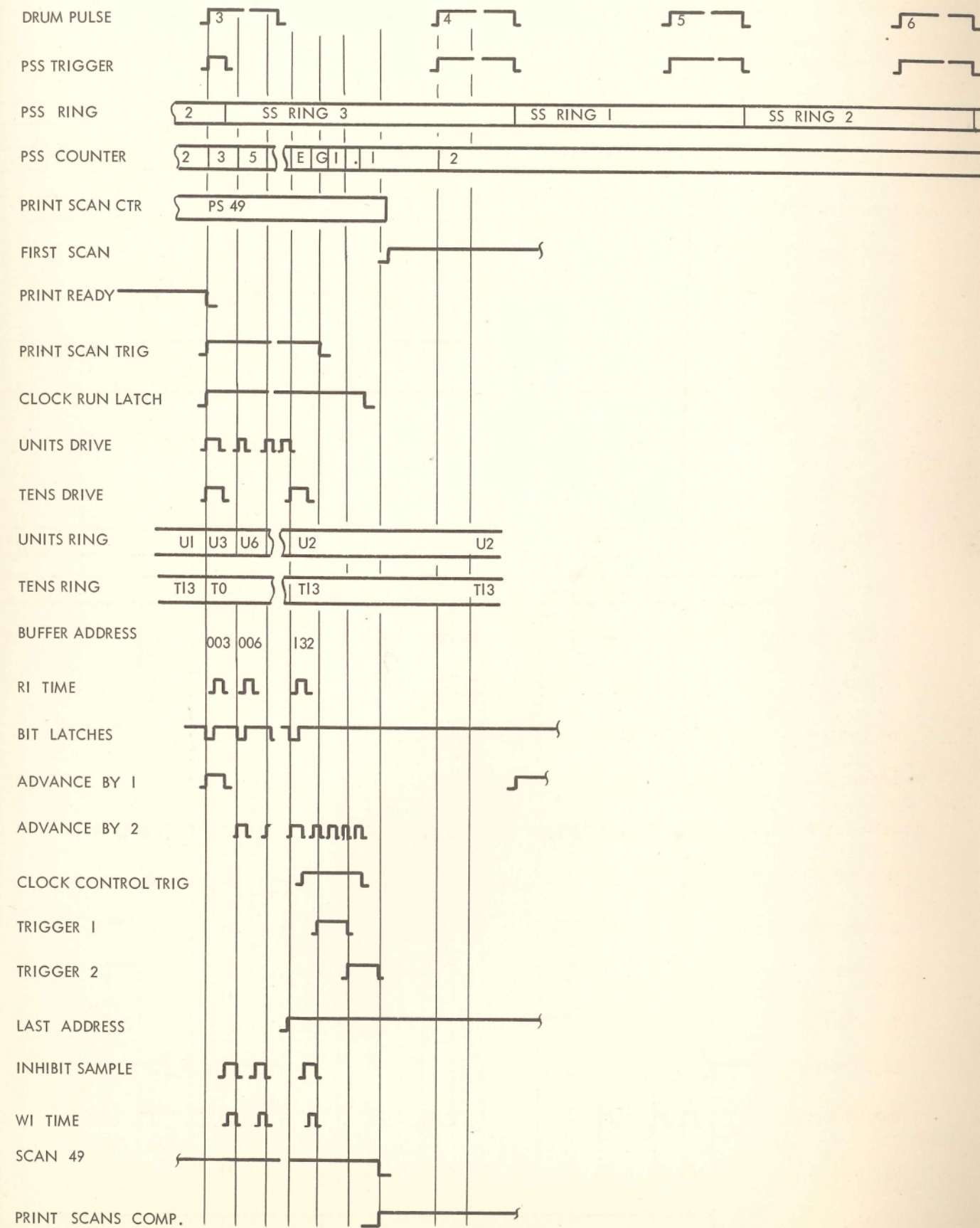

# PRINT OP—NON-BUFFER

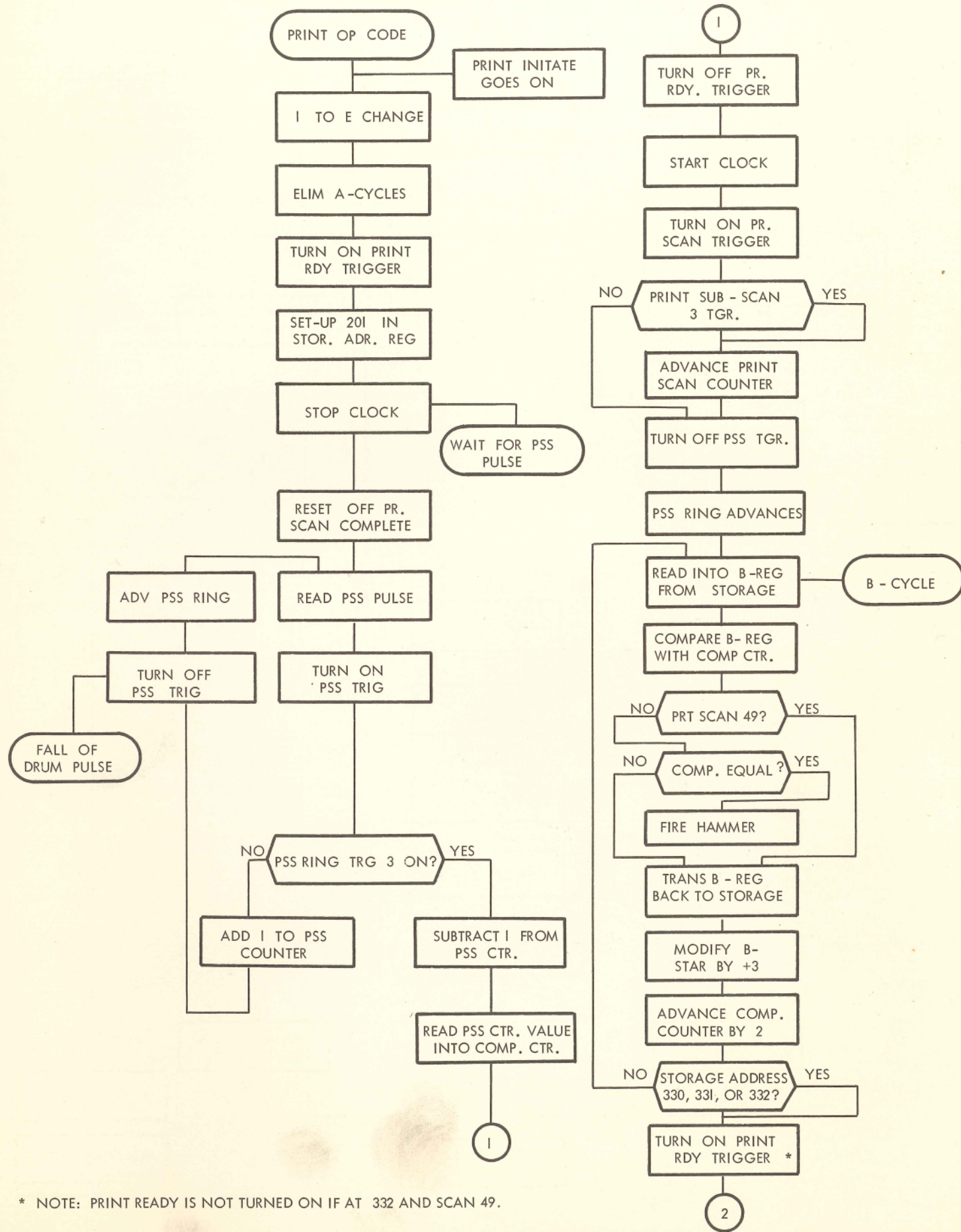

\* NOTE: PRINT READY IS NOT TURNED ON IF AT 332 AND SCAN 49.

# PRINT OP—NON-BUFFER

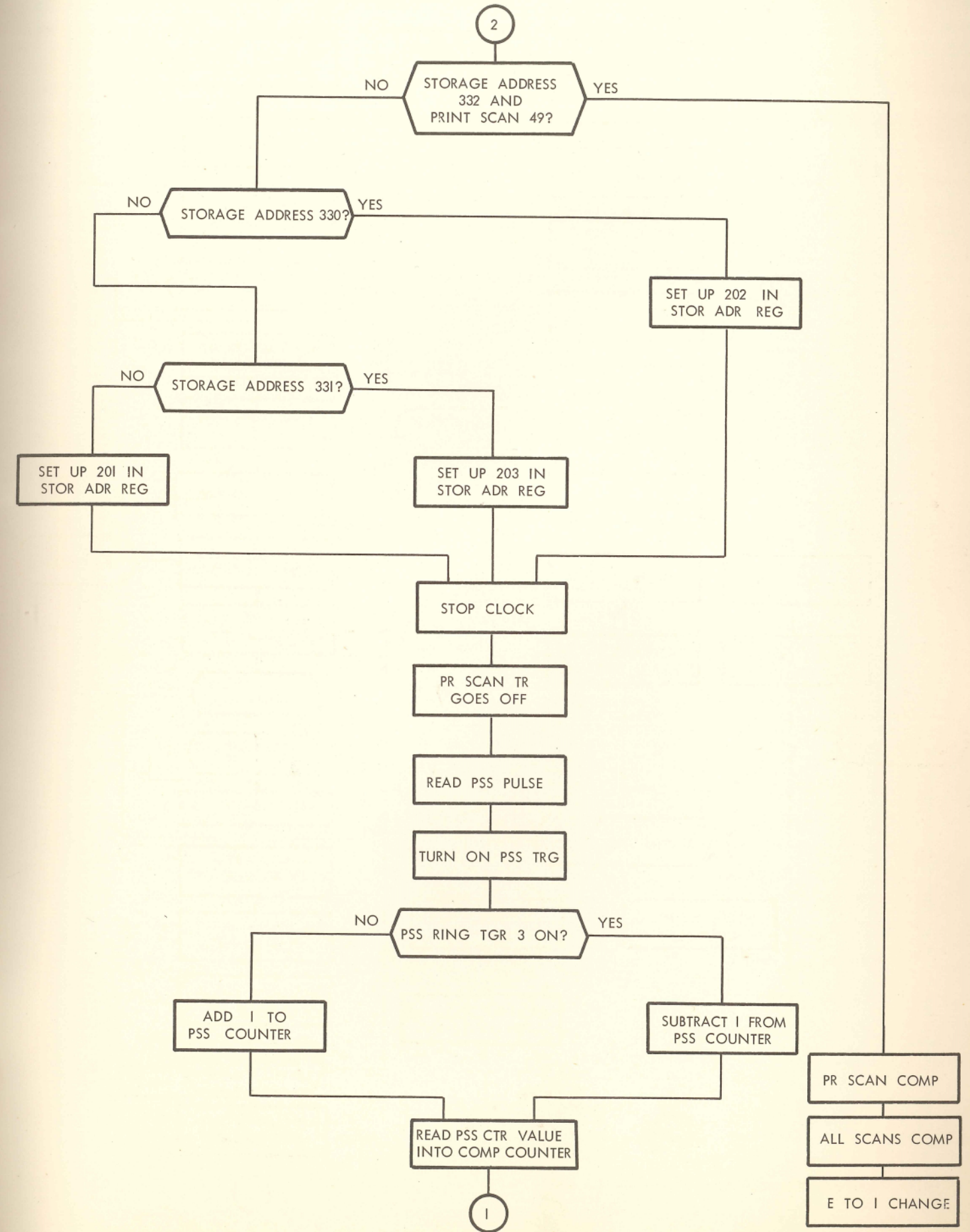

# PRINT OP TIMING—NON-BUFFER

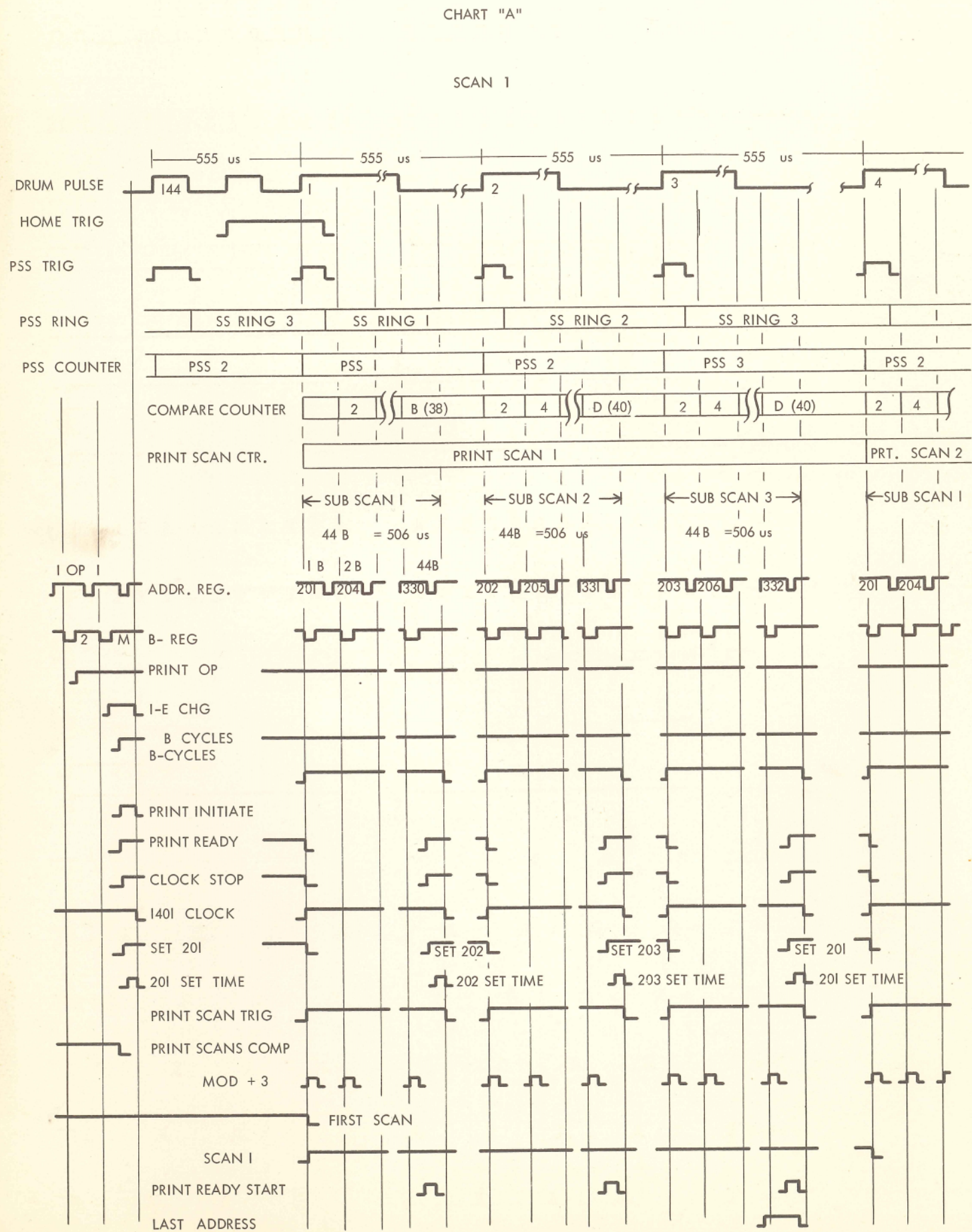

# PRINT OP TIMING—NON-BUFFER

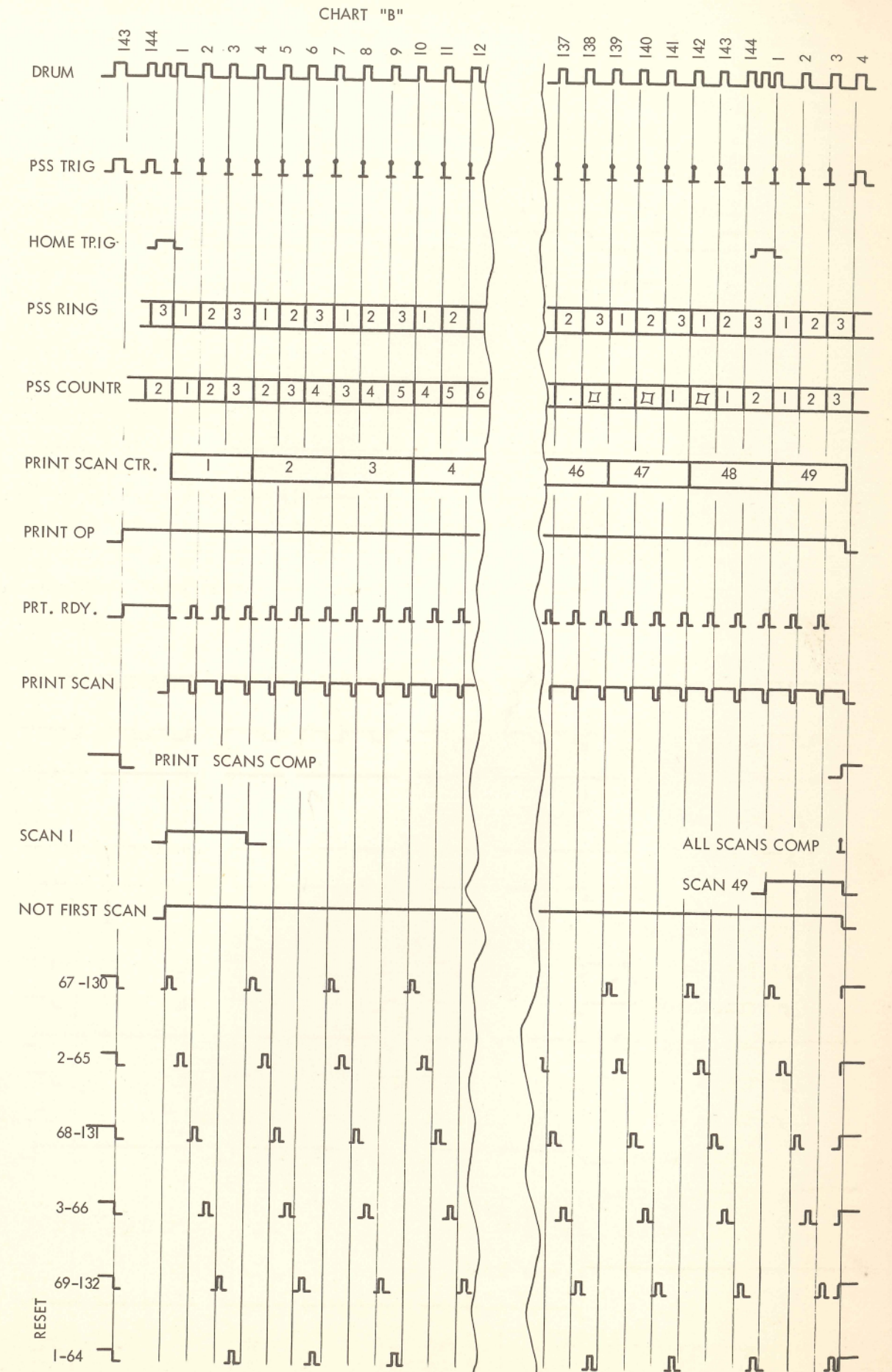

# PRINT OP TIMING — NON-BUFFER

CHART "C"

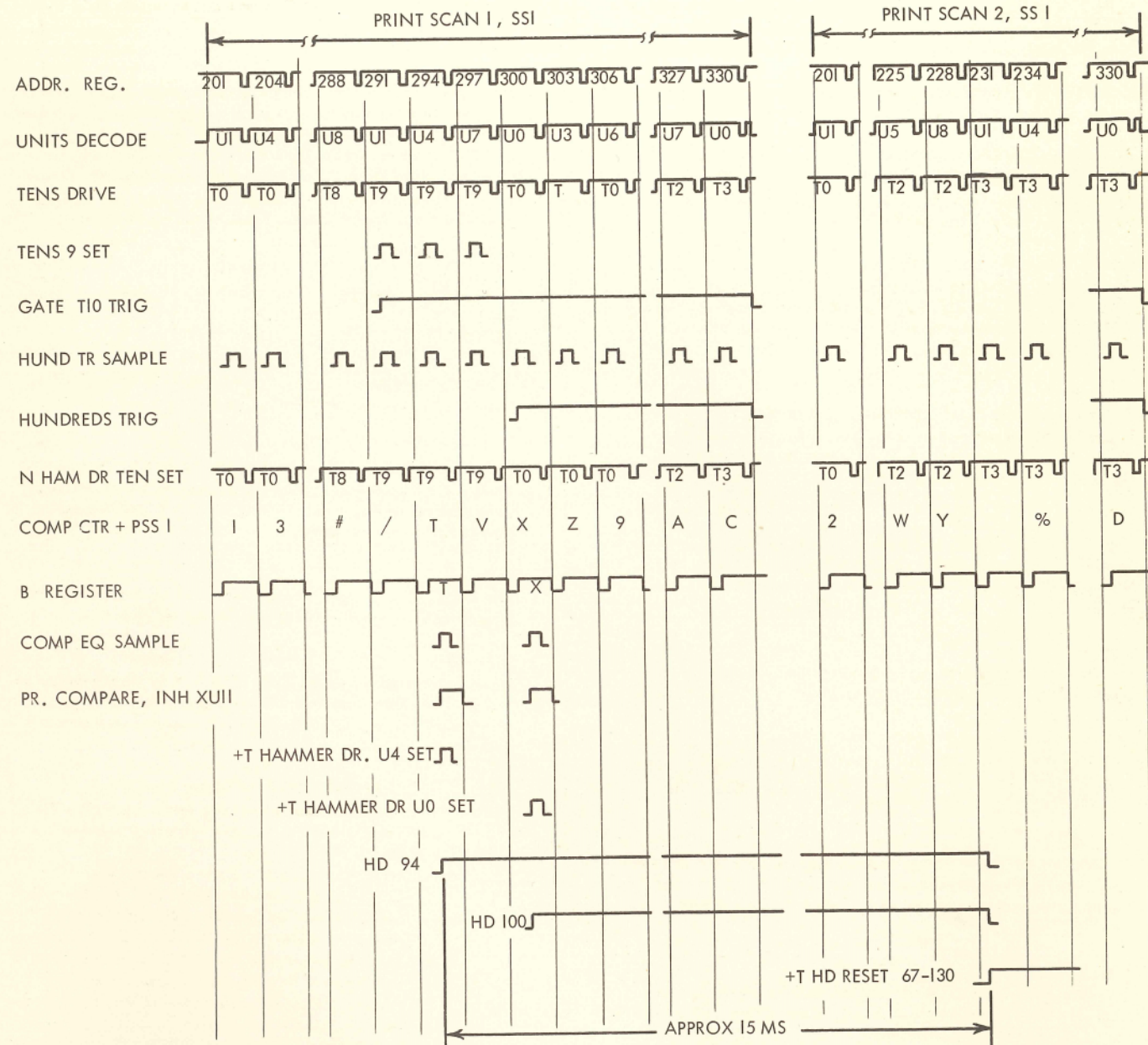

PRINT	T	E	A	T	A	X	
	94	95	96	97	98	99	100
	S-1	S-26	S-21	S-46	S-19	S-1	
	SS-1	SS-2	SS-3	SS-2	SS-3	SS-1	

- 1) TIE HOME PULSE TO PRINT READY TRIG (SEE S.H. 58) TO START PRINTING AT HOME TIME.
- 2) THE WORDS TEA TAX ARE STORED IN POSITIONS 94-100 THIS IS TO ILLUSTRATE WHAT SCAN AND SUB SCAN THE POSITION WILL FIRE (REFERENCE CAN BE MADE TO TABLES A & B)

# PRINT CHECK SERVICE HINTS

## S.H. 55 INTERMITTENT PRINT CHECKS

Intermittent print checks that occur on certain print patterns or in various positions are often caused by loss of -60V return to hammer response cores. The most common cause for loss of this voltage is blown fuses which are located on O1A4 on A Models and O2A4 TB5 on other models. The best method is to isolate the fuses and check them with a meter.

## S.H. 56

All counters and rings may be checked by wiring a timing pulse to drive them. This will check the rings at I401 speed and all the triggers may be scoped. All CW Triggers should be on within 1.5 microseconds with overshoot.

## S.H. 57

Troubleshooting can be difficult with Print Storage when Printer Busy and Carriage Busy interlocks are effective. This difficulty can be virtually eliminated by utilizing a Branch on Printer or Carriage Busy.

## S.H. 58

Tie Home pulse to "and" condition which turns off Print Ready Trigger to allow printing at home time only. (O1A6B07H 36.31.31. to O1A6A10N 36.31.11) Refer to ALD's to check tie points for that particular I403.

## S.H. 59

The "Print Word Mark" test I010B can be a useful tool in determining which position is causing false print checks. With the error check stop switch "on" the last position printed on the last print line will be the error position.

## S.H. 60

Do not force machine to run by holding the I/O check reset switch or the printer check reset keys on. This can cause damage by blowing Hammer driver fuses. Remove the -60V returns to the hammer magnets. This is accomplished by removing 2 black wires on the I2 position terminal in gate O1B8. The cores will be set but no printing will take place. The I/O reset switch can now be held on.

## S.H. 61

To lock the printer in a tight loop so that the counters and rings may be checked remove and float scan 16 and 32 from the block that develops scan 49. The printer will restart after one print scan.

## S.H. 62

The later I403 machines have a nylon residual over the print magnets. This nylon may bunch due to the holding bands breaking at either end. This can cause intermittent failures to print with no print checks.

## S.H. 63

A good print magnet coil will measure approximately 11 ohms alpha numeric and 6 ohms numeric. Coils will partially short causing printing to fail but no print check. Measure from the output pin of hammer drive card to pin P which is the -60 volt return. The resistance of coil when disconnected should be  $8.3 \pm .4$  ohms - alpha-numeric or  $4.0 \pm .2$  ohms for numeric type.

## S.H. 64

To shoot print storage failures it may be advantageous to prevent any printing and repeat only the Print transfer. This may be accomplished by tying Print Scan Complete to Print transfer complete. The print operation will be stopped at the

end of the print transfer. The removal of CR Card in O1A4 C07 will allow you to get an output from the presence amplifiers of the buffer during the transfer for 1, 2, 4 and 8 bits. Removal of the CR Card in C08 will allow outputs for the A, B, C and WM bits. (46.10.61.2)

## S.H. 65

Intermittent print checks can be caused by the absence of -60 volts on O1B5 Pin P of hammer drive cards. This is a suppression diode return voltage for the hammer drivers. The print position which is in error as indicated by storage scan, can point out which driver cards to check for missing -60 volts or bad suppress diodes. A hammer driver that is not being suppressed will appear similar as shown in the Fig. below.

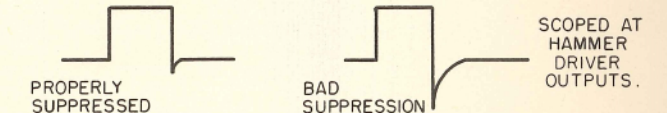

It should be kept in mind that one or more hammer drivers not being suppressed can cause print checks in other positions that may be printing on different scans.

## S.H. 66

Individual hammer flight time can be checked by using 4 part forms. The impression left by the hammer on the fourth copy should be centered on the printing. The hammer impression should frame the character.

## S.H. 67

The loss of plus 6 volts to gate O1B5 will burn out the print magnet coils without blowing hammer driver fuses.

## S.H. 68

Some hammer driver cards, P/N 371940, may have wrong size fuses. The proper fuse is 1 1/2 amps and color coded purple any yellow. The incorrect size is 3/4 amp and coded purple and orange.

## S.H. 69 ISOLATE ERRORS (Print -Reset Checks)

1. When trouble shooting print or reset checks it will save time to isolate the conditions which are or'd to turn on the check triggers. The following is a method to isolate the trouble.
  - a. Cards can be placed on extenders and the output pin disconnected providing the load is not on the card. Refer to the SMS card wiring diagram.
  - b. Extender input to the and ckts. can be scoped to determine if that circuit is causing the error. NOTE: Extender test points are indicated on the later A.L.D.'s.
2. If the reset check triggers are failing, the printer will also fail with C bits in the print area.

## S.H. 70 SYNC POINTS (Print Checks)

1. The firing of a particular position can be used as a sync. point. Use the hammer fire line, not the hammer response line.
2.
  - a. "Not first scan", or "Print scan complete" can be used as sync points.
  - b. "Not transfer" can be used to check transfer of information from I401 to Print Buffer. (Print Buffer System only)
  - c. Refer to "Print Buffer Timing Charts" (A,B,C,) Pgs. 47-49 or "Print OP Timing Charts" (A,B,C) Non-Buffer Pgs. 52-54 for check points.
3. Dual triggering can be used to obtain stable sweep.
  - a. Use "print scan" (36.31.41.) to trigger main sweep.
  - b. Use "Print Initiate" (36.31.31.) to trigger delayed sweep. The desired print scan be observed. Refer to S.H. 76 Scope Operating Hints.

S.H. 71 BLOWING HAMMER DRIVE FUSES

- Chain drive motor slowing down can cause blowing of hammer driver fuses. At times the motor slowing down can be heard. Scope drum pulse. Refer to S.H. 47. Checking should be done while printing. This puts a load on the chain drive motor. Sync checks may not occur along with the Print checks.
- Hammer position firing more than once during a print scan can cause blown fuses.
- Check hammer driver reset lines. Refer to "Hammer Reset and Reset Check timing Chart" (Fig. 27). Print with C's in print area.

- There is a possibility of some circuit malfunction turning off delta process prior to a print op. Print Scans will take place but 20l remains in main star. This can cause hammer driver fuse 1 to blow.
- Missing P.S.S. pulses or anything that interrupts the normal sequence of print scan. The following may cause this:
  - Open cable from Drum head to amplifiers.
  - Too much air gap between head and drum.
- Bind in chain.
- Wear in bevel drive gears or intermediate drive gears.

### HAMMER RESET & RESET TIMING

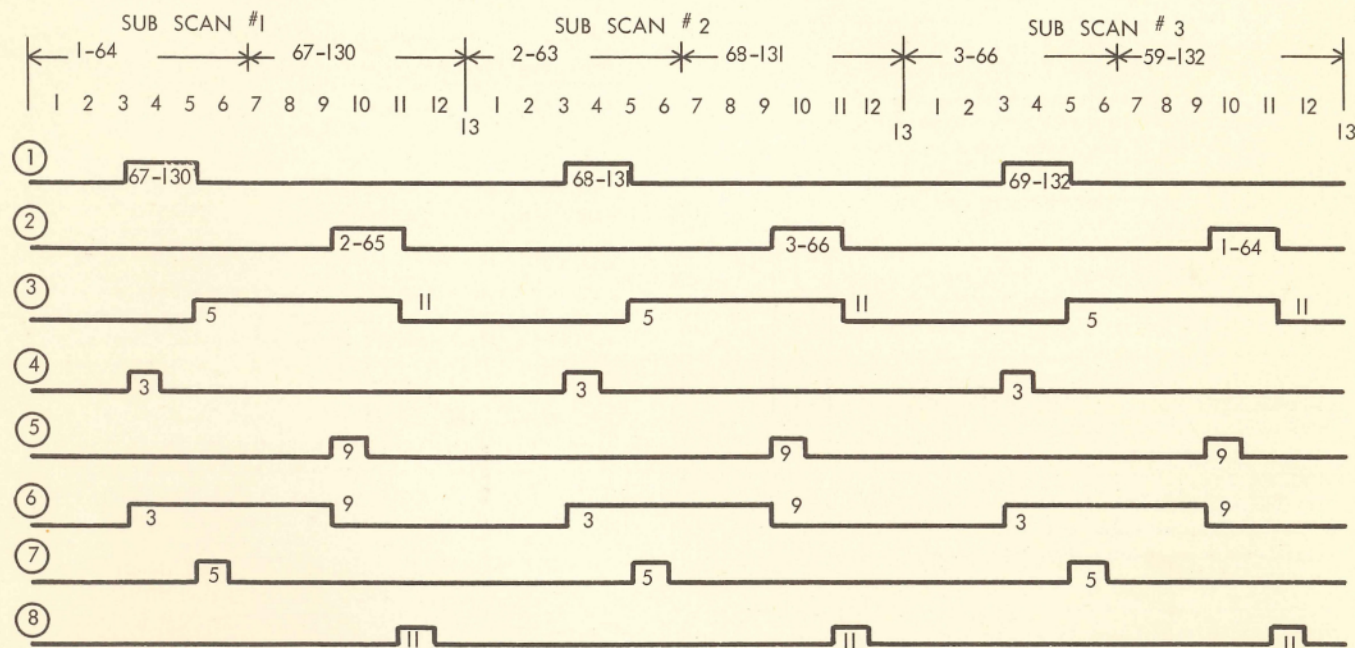

- RESETS EVERY THIRD SPECIFIED POSITION- EX. FROM TENS 3 TO TENS 5 TIME OF SUB SCAN #1 RESET EVERY THIRD POSITION STARTING AT 67 AND ENDING AT 130
  - RESETS EVERY THIRD SPECIFIED POSITION- EX. FROM TENS 9 TO TENS 11 OF SUB SCAN # 3 RESET EVERY THIRD POSITION STARTING AT 1 AND ENDING AT 64.
  - THIS IS A TRIGGER THAT IS TURNED ON AND OFF BY TENS DRIVE LINES. CHECKED FOR CORRECT OPERATION BY LINE 4 AND 5
  - THIS IS A BINARY TRIGGER THAT GOES ON AND OFF UNDER THE CONTROL OF THE RESET DRIVE LINES. CHECKED FOR CORRECT OPERATION BY LINE 7 AND 8
- IF ANY CONDITION FAILS TO BE MET THE RESET CHECK LATCH IS TURNED ON. THE RESET CHECK LATCH WILL FORCE AN IMMEDIATE RESET TO ALL HAMMER DRIVERS.

FIG. 27

### PRINT CHECK LOGIC

S.H. 72 PRINT CHECKS

Refer to "Print Check Logic Diagram" below.

- A print error will occur if the hammer did not fire with a compare equal signal; or if a hammer fired without a compare equal signal. And circuits 1,2 accomplish this checking during scans 2-49.
- A print check will occur if the same position has more than one print compare equal or an unprintable character is followed by a print compare equal. And ckt. 3 does this checking during scans 2-49.
- A print error will result if during scan 49 there is a core in the Print Fire Complete plane still zero. This indicates all print positions did not receive a

- print compare equal or unprintable character signal.
- And circuit 5 is used to retain errors in the Print error plane on successive scans.
- The print buffer latches are checked for correct parity during print transfer (140l Storage to Print Buffer) and during print scans.
- A print check will hold all scans complete trigger off this prevents Delta process from turning on. (Non Buffer Systems)
  - A print error brings up "Print scan end." This along with the next print transfer turns off Delta Process) (Print Buffer Systems)

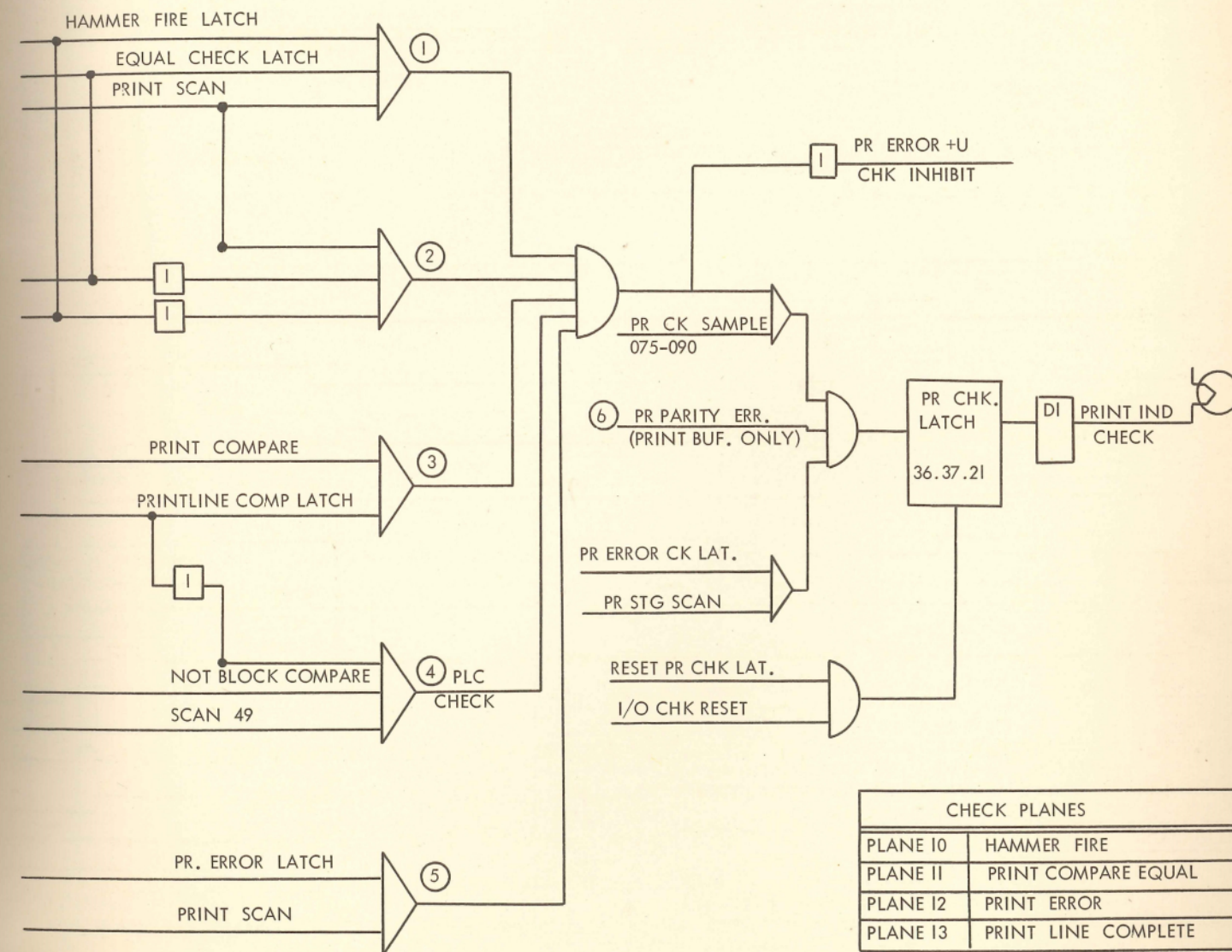

NON BUFFER PRINT CHECK CKTS. ARE SIMILAR TO THE PRINT BUFFER SYSTEM. SOME OF THE DIFFERENCES ARE NOTED.

REFER TO S.H. 72

# RESET CHECK LOGIC

## S.H. 73 RESET CHECK

1. The following condition can cause the reset check latch to turn on: Refer to :Reset Check Logic Diagram" below.
  - A. If the same position has more than one print compare equal or an unprintable character is followed by a print compare equal. And circuit "a" performs this checking for Non Buffer machines only.
  - B. And "b" performs the same checking as and ckt. "a" does. This particular circuit is used on Print Buffer system only.
  - C. And ckt. "c" will check for a hammer being fired without compare equal signal. This check is done on Buffer Systems only.
  - D. And ckt. "d" is used to turn on reset check latch if the "T" casting is opened while printing.
2. A check is made of storage and Hammer selection during printing. The detection of an error turns on the reset check latch. These conditions are:
  - E. T9 and ten drives check trigger (T5-T11)off. Refer to and ckt. "e".
  - F. T-3 and tens drive check trigger (T5-T11)on. Refer to and ckt. "f".
  - G. T-5 and hammer reset check trigger (T3-T9) off and (Print Scan I" - Non Buffer) or ("no print

scan complete" - Print Buffer System).

- Refer to Fig. g.
- H. T-11 and hammer reset check trigger (T3-T9) on. Refer to and ckt. h.
  - J. Storage address error and print scan (Non Buffer System only). Refer to and ckt. j.
  - K. Ring check trigger will be turned on if the tens ring is not sitting at T-13 at the end of a print scan. This ckt. is used on Print Buffer System only.
  - L. There is no reset check indication. A reset check condition will cause a print check. This is due to the normal print check circuits detecting hammers failing to fire.
  - M. When the 1401 stops on a print check, it will be necessary for you to determine if it was due to a reset check. Scope the output of the reset check latch.
  - N. Do not print with the I/O check reset switch held on. This will hold the reset check latch off. If there is a reset failure, it will not turn on the reset check latch. The result of this will be blown hammer driver fuses. (Refer to S.H. 60)
  - P. Print scans complete holds the print hammer drivers reset.

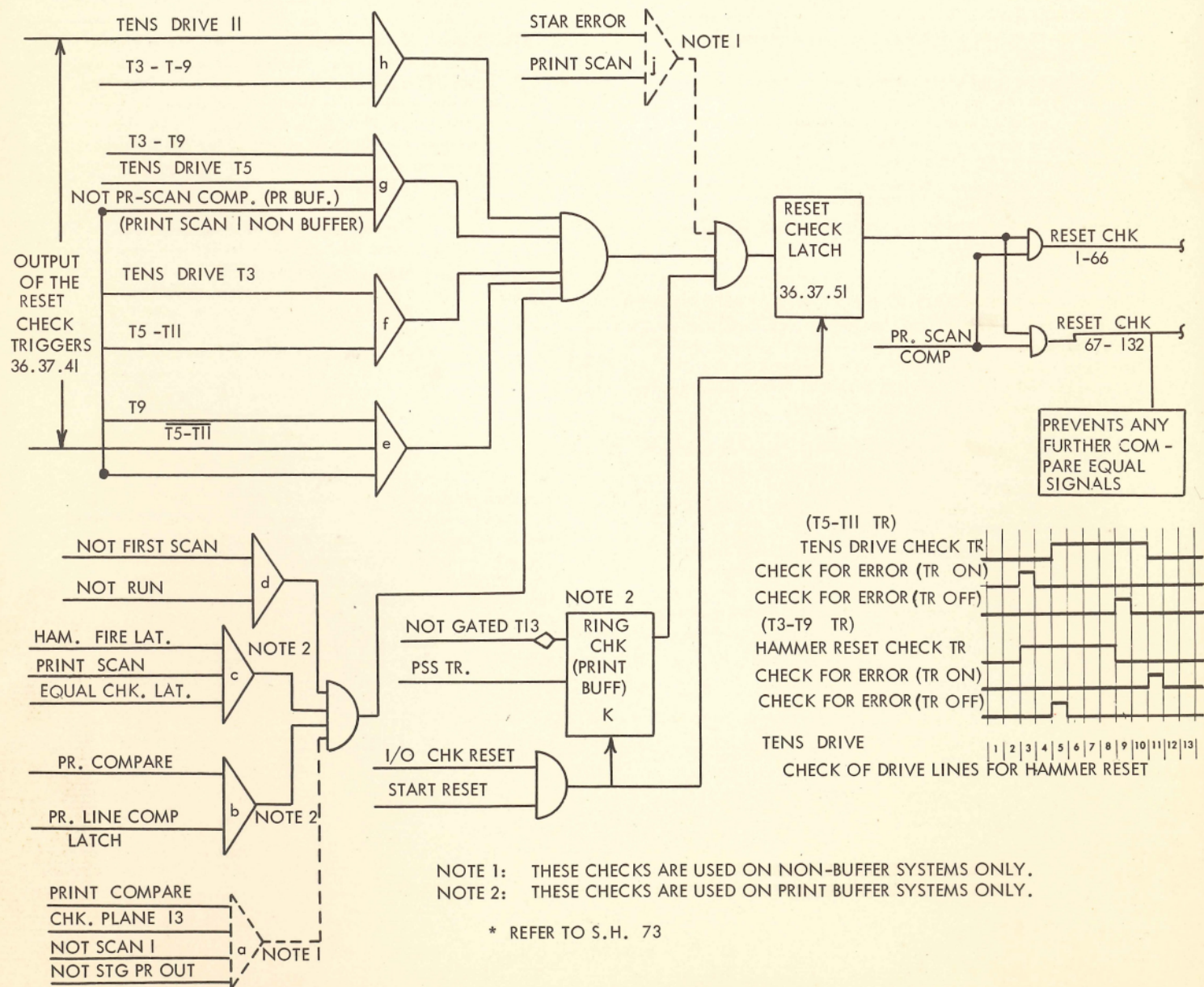

## S.H. 74 PRINT CHECKS CAUSED BY NOISE

If print checks seem to be caused by noise, a GJ -- card, Part # 371501 should be installed in the gate in question to reduce noise. The card must be installed in an empty position where the voltage buss is connected. More than one card may be installed in the same gate, if one doesn't reduce the noise sufficiently.

## S.H. 75 DISPLAY PRINT BUFFER - 1401

1. Use the address stop position of mode switch to stop at address just before the print operation. Turn switch to I/E and depress start key twice so that the desired line of information to be displayed is printed.
2. Turn mode switch to Alter. Alter position to be displayed with invalid character. 201 can be altered with invalid character if CE desires to display print buffer, starting with 001. BE SURE Print Scan switch is off.
3. Depress check Reset, and I/O Reset.
4. Turn switch on Auxiliary Console to Print Storage Scan.
5. Turn mode switch to Storage scan.
6. Depress Start Key.

Scan will stop at the address that contains invalid character. 1401 storage will be displayed in "B" Register. Content of print buffer will be displayed in "A" Register. DO NOT DEPRESS RESET KEY. For each depression of the start key you are able to display the next position in print buffer.

7. Depress Reset key to allow scoping of the invalid character again.

1401- 25,000- Series It is only necessary to open "T" Casting to display print buffer. With this method we start displaying at 201 in B Register and position 001 of print buffer in A Register. We advance 1 position for each depression of start key.

The above procedure can be used as a faster method to display upper part of print buffer.

## S.H. 76 SCOPE OPERATING HINTS (DELAY SWEEP FEATURE)

The sweep Delay Feature should be used on most service calls which require a scope because it practically eliminates the time-consuming problem of obtaining a good sync on the OP Code and initiate the appropriate amount of delay. 100 ms is the maximum delay on the "no-suffix" scopes.

1. Setup for Delayed Sweep
  - a. The assumption is made that scope is set up normally and that the desired signal cannot be observed in detail.
  - b. Set the Main Sweep Stability clockwise until "FREE RUN" occurs.
  - c. Move the sync lead to the Delay Sweep Trigger hub.
  - d. Set the Delay Trigger "SLOPE" toggle switch to the proper polarity.
  - e. Set the Delay Sweep "TIME/CM" switch at a time equal to the Main Sweep "TIME/CM" including the Main Sweep Multiplier if the scope has one.

- (It may be necessary to go one position slower than the Main Sweep if the variable Main Sweep control is being used and the signal to be expanded is near the right end of the trace).
- f. Set the Delay Sweep Multiplier at about 0-05 (the horizontal sweep may not function at exactly 0-00).
  - g. Set the Display switch to "Main Sweep Delayed". (A delayed by B on some scopes).
  - h. Adjust the Delay Sweep STABILITY AND TRIGGERING LEVEL controls in the normal manner to obtain a stable sweep. This will result in the same display as that being observed prior to changing to Delayed Sweep because the Delay Multiplier is causing very little delay (the desired signal may have moved to the left somewhat if the Delay TIME/CM was set slower than the Main Sweep TIME/CM in Step e).
  - i. Turn the Delay Time Multiplier until the desired signal approaches the left side of the screen. The Main Sweep can then be changed to expand it. This step may be repeated to further expand the signal.

2. "Triggered" Delayed Sweep
 

The above procedure works well when the total delay is less than about 10 ms. The expanded signal may "jitter" and make diagnosis uncertain (if much jitter is present for delays less than 10 ms, the scope delay circuits or the machine oscillator may be suspected of malfunctioning). Jitter of the signal may be removed by causing the Main Sweep to start on a machine time pulse or gate after the Delay Sweep generator has timed out. This is quite easily accomplished as follows:

  - a. Turn the Main Sweep STABILITY counter-clockwise until no more traces appear.
  - b. Attach the desired clock pulse or gate to the Main Sweep TRIGGER hub.
  - c. Adjust the Main Sweep TRIGGER LEVEL AND SLOPE properly. The sweep now starts with the first machine pulse received after the sweep delay has occurred.

NOTE: Since the sweep can only start with a machine clock pulse, the signals will "jump" as the Delay Multiplier is rotated. This will have to be considered when expanding the signal as described in Step 1 - i.

The Delayed Sweep feature can be used to its greatest advantage by having the scope set up on Delayed Sweep at all times that EXT. sync is being used. Whenever delay is required, it is only necessary to advance the DELAY TIME/CM AND MULTIPLIER controls to obtain the desired delay. One point should be kept in mind if this method is used -- when "no delay" is desired, keep the Delay TIME/CM set at two micrometers with the Delay TIME/CM set to the slower ranges even though the MULTIPLIER is very close to 0-00.

# PRINTABLE CHARACTER TABLE

S.H. 77 PRINTABLE CHARACTER TABLE EXPLANATION  
This explanation shows how Tables A and B can be used. With the two tables you can determine what character will print in a certain print position and on what scan it will occur when the home pulse is wired to print ready.

- To find what is optioned to print in any print position on scan 1, find the print position you are interested in on Table B. The character beside the print position, will be optioned to print on scan 1.
- To find what scan a particular character will be optioned to print in a specified print position, find what character will print in that position on scan 1 from Table B. Locate that same character in Table A. Start to count with that character to find out what will be printed on succeeding scans. When the bottom of the table is reached, go to the top and continue counting.

Example: On what scan will print position 90 be optioned to print a 4 with the home pulse tied in? Find print posi-

- tion 90 in Table B. This tells you that a / will be optioned to print on scan 1. Now find the / in Table A. Start counting down the chart until you come to the character 4. The 4 will be optioned to print in position 90 on scan 4. Table B is the chain break pattern and should not be stored in the machine in its entirety. This pattern will cause the chain to break with about 9 minutes of printing. Most machines will give print checks if between 12 and 20 characters are printed on the same sub scan.
- Tables A and B can be used to create a good sync point. If you are having trouble printing in a certain position, find that position in Table B. Enter the character that is optioned to print in scan 1 for that position. Count back 3 positions and enter the character that will be optioned to print there on scan 1 (same sub scan). Sync on the hammer fire line for that position. This is the B cycle just previous to the cycle that you are interested in observing.

Scan	Character	Bit Structure	Print Position			Character			Print Position			Character			Print Position			Character					
			Character	Sub Scan	Print Position	Character	Sub Scan	Print Position	Character	Sub Scan	Print Position	Character	Sub Scan	Print Position	Character	Sub Scan	Print Position	Character	Sub Scan	Print Position			
1	1	1	1	1	23	U	2	45	P	3	67	I	1	89	@	2	111	L	3				
2	2	2	2	2	24	V	3	46	P	1	68	&	2	90	/	3	112	L	1				
3	3	3	3	3	25	V	1	47	Q	2	69	.	3	91	/	1	113	M	2				
4	4	4	4	3	1	26	W	2	48	R	3	70	.	1	92	S	2	114	N	3			
5	5	5	5	5	4	2	27	X	3	49	R	1	71	□	2	93	T	3	115	N	1		
6	6	6	6	6	6	5	3	28	X	1	50	-	2	72	1	3	94	T	1	116	O	2	
7	7	7	7	7	7	7	1	29	Y	2	51	\$	3	73	1	1	95	U	2	117	P	3	
8	8	8	8	8	8	8	2	30	Z	3	52	\$	1	74	2	2	96	V	3	118	P	1	
9	9	9	9	9	9	9	3	31	Z	1	53	*	2	75	3	3	97	V	1	119	Q	2	
10	0	10	0	10	0	10	1	32	+	2	54	A	3	76	3	1	98	W	2	120	R	3	
11	#	11	#	11	#	11	2	33	,	3	55	A	1	77	4	2	99	X	3	121	R	1	
12	@	12	@	12	@	12	3	34	,	1	56	B	2	78	5	3	100	X	1	122	-	2	
13	/	A1	/	A1	/	A1	1	35	%	2	57	C	3	79	5	1	101	Y	2	123	\$	3	
14	S	A2	S	A2	S	A2	2	36	J	3	58	C	1	80	6	2	102	Z	3	124	\$	1	
15	T	A3	T	A3	T	A3	3	37	J	1	59	D	2	81	7	3	103	Z	1	125	*	2	
16	U	A4	U	A4	U	A4	1	38	K	2	60	E	3	82	7	1	104	+	2	126	A	3	
17	V	A5	V	A5	V	A5	2	39	L	3	61	E	1	83	8	2	105	,	3	127	A	1	
18	WA	A6	WA	A6	WA	A6	3	40	L	1	62	F	2	84	9	3	106	,	1	128	B	2	
19	XA	A7	XA	A7	XA	A7	1	41	M	2	63	G	3	85	9	1	107	%	2	129	C	3	
20	YA	A8	YA	A8	YA	A8	2	42	N	3	64	G	1	86	0	2	108	J	3	130	C	1	
21	Z	A9	Z	A9	Z	A9	3	43	N	1	65	H	2	87	#	3	109	J	1	131	D	2	
22	+	A10	+	A10	+	A10	1	44	O	2	66	I	3	88	#	1	110	K	2	132	E	3	
23	,	A11	,	A11	,	A11	2																
24	%	A12	%	A12	%	A12	3																
25	J	B1	J	B1	J	B1	1																
26	K	B2	K	B2	K	B2	2																
27	L	B3	L	B3	L	B3	3																
28	M	B4	M	B4	M	B4	1																
29	N	B5	N	B5	N	B5	2																
30	O	B6	O	B6	O	B6	3																
31	P	B7	P	B7	P	B7	1																
32	Q	B8	Q	B8	Q	B8	2																
33	R	B9	R	B9	R	B9	3																
34	-	B10	-	B10	-	B10	1																
35	\$	B11	\$	B11	\$	B11	2																
36	*	B12	*	B12	*	B12	3																
37	A	AB1	A	AB1	A	AB1	1																
38	B	AB2	B	AB2	B	AB2	2																
39	C	AB3	C	AB3	C	AB3	3																
40	D	AB4	D	AB4	D	AB4	1																
41	E	AB5	E	AB5	E	AB5	2																
42	F	AB6	F	AB6	F	AB6	3																
43	G	AB7	G	AB7	G	AB7	1																
44	H	AB8	H	AB8	H	AB8	2																
45	I	AB9	I	AB9	I	AB9	3																
46	&	AB10	&	AB10	&	AB10	1																
47	.	AB11	.	AB11	.	AB11	2																
48	□	AB12	□	AB12	□	AB12	3																

TABLE B  
1403 CHARACTERS PRINTABLE DURING SUB SCAN 1,2,&3 OF SCAN 1

TABLE A SHOWS SCAN ON WHICH A PARTICULAR CHARACTER WILL PRINT IN POSITION 1 WITH PRINT-READY TIED TO HOME PULSE

# UNITS & TENS DRIVER OUTPUT

UNITS WRITE DRIVE 01A4C21C TEST POINTS  
TENS WRITE DRIVE 01A4C21E

SYNC WI TIME 01A4D21D  
VERTICAL DEF. 0.2 V/DIV.  
HORIZONTAL DEF. 0.5 US X5 MAG.

PRINT BUFFER - IF TWO UNITS OR TWO TENS LINES ARE UP AT THE SAME TIME, ALL LOCATIONS OF BUFFER CORE WILL FAIL.

SCOPE INTENSITY MUST BE FULLY CLOCKWISE.  
HINT

WHEN TROUBLESHOOTING IN BUFF., A CURRENT PROBE WILL BE OF GREAT ASSISTANCE. THE NEW CURRENT PROBE PART NUMBER IS 45I213 AND THE TERMINATOR 45I214. IT SHOULD BE NOTED THAT THE PROBE HEAD CAN BE GROUNDED WHEN OPEN SO CARE SHOULD BE TAKEN TO PREVENT DAMAGE TO THE CORE.

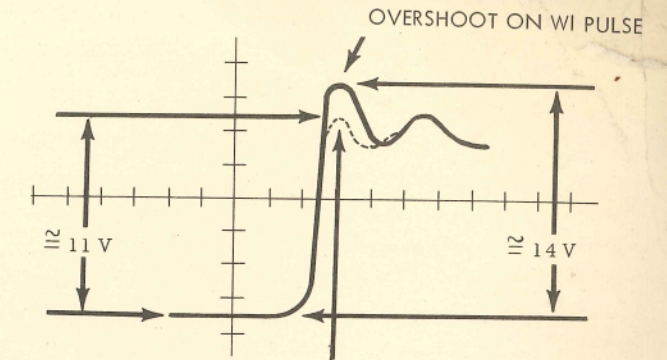

DOTTED LINE REPRESENTS TRACE SEEN WHEN TWO TENS OR UNITS POSITIONS ARE ADDRESSED AT THE SAME TIME.

NOTE: CORRECT WAVESHAPES WILL ALSO APPEAR AS LIGHT TRACE WHEN FAILING POSITION IS BEING ADDRESSED.

FIGURE 28

# STORAGE PRINT OUT

